

INSTRUCTION



ALVIA

REGIOLUX

ALIMP LC05 / LC01
4215

Diese Leuchte enthält ein Leuchtmittel der Energieeffizienzklasse C
This luminaire contains a light source of energy efficiency class C

Regiolux GmbH
Hellinger Str. 3
D-97486 Königsberg/Bay.
T 09525 89-0
<http://www.regiolux.de>
info@regiolux.de

Achtung:
Leuchte nicht öffnen!
Garantieverlust!

Attention:
Don't open the luminaire!
Loss of Guarantee!

Attention:
N'est pas ouvrir le luminaire!
Perte de garantie!

Atención:
Non abrir la luminara!
Pérdida de garantía!

Art.-Nr.: 530450 12/20

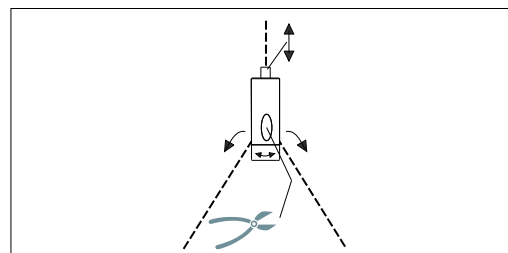
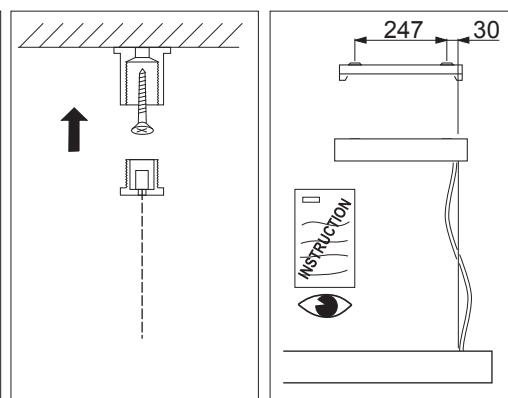
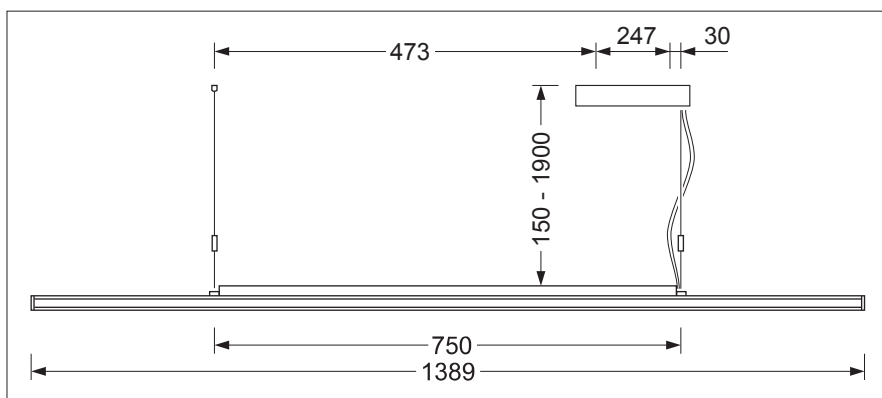

<p>alvia ALIMPR DALI LC05</p> <p>3 Netz/mains</p>	<p>- Ein / Aus / Tast-Dim - Direktes und indirektes Licht wird getrennt gesteuert.</p> <p>- On / Off / Touch dim - Direct and indirect light is controlled separately.</p> <p style="text-align: center; font-size: 1.2em;">I max. 10 A</p>	<table style="width: 100%; border-collapse: collapse;"> <tr> <td style="text-align: right; padding-right: 5px;">ext.</td> <td style="border: 1px solid black; padding: 2px;">3</td> <td style="border: 1px solid black; padding: 2px;"></td> <td style="border: 1px solid black; padding: 2px;"></td> <td style="text-align: left; padding-left: 5px;">int.</td> <td style="border: 1px solid black; padding: 2px;">tr/tr</td> </tr> <tr> <td style="border-right: 1px solid black; padding-right: 5px;">N</td> <td style="border: 1px solid black; padding: 2px;">N</td> <td style="border: 1px solid black; padding: 2px;">⊕</td> <td style="border: 1px solid black; padding: 2px;">1</td> <td style="border-right: 1px solid black; padding-right: 5px;"></td> <td style="border: 1px solid black; padding: 2px;">bl/bl</td> </tr> <tr> <td style="border-right: 1px solid black; padding-right: 5px;">PE</td> <td style="border: 1px solid black; padding: 2px;">1</td> <td style="border: 1px solid black; padding: 2px;">2</td> <td style="border: 1px solid black; padding: 2px;"></td> <td style="border-right: 1px solid black; padding-right: 5px;"></td> <td style="border: 1px solid black; padding: 2px;">gnge/gnye</td> </tr> <tr> <td style="border-right: 1px solid black; padding-right: 5px;">L</td> <td style="border: 1px solid black; padding: 2px;">2</td> <td style="border: 1px solid black; padding: 2px;"></td> <td style="border: 1px solid black; padding: 2px;"></td> <td style="border-right: 1px solid black; padding-right: 5px;"></td> <td style="border: 1px solid black; padding: 2px;">bn/bn</td> </tr> <tr> <td style="border-right: 1px solid black; padding-right: 5px;"></td> <td style="border: 1px solid black; padding: 2px;"></td> <td style="border: 1px solid black; padding: 2px;"></td> <td style="border: 1px solid black; padding: 2px;"></td> <td style="border-right: 1px solid black; padding-right: 5px;"></td> <td style="border: 1px solid black; padding: 2px;">sw/bk</td> </tr> </table>	ext.	3			int.	tr/tr	N	N	⊕	1		bl/bl	PE	1	2			gnge/gnye	L	2				bn/bn						sw/bk
ext.	3			int.	tr/tr																											
N	N	⊕	1		bl/bl																											
PE	1	2			gnge/gnye																											
L	2				bn/bn																											
					sw/bk																											

<p>alvia ALIMPR DALI LC01</p> <p>3 Netz/mains</p> <p>2 optional DALI out</p> <p>2 optional push-button Taster/ push-button</p>	<p>- Ein / Aus / Tast-Dim / Tageslichtregelung / Bewegungs- und Präsenzerkennung / Fernbedienung - Direktes und indirektes Licht kann getrennt oder gemeinsam gesteuert werden.</p> <p>- On / Off / Touch dim / Daylight control / Motion and presence detection / Remote control - Direct and indirect light can be controlled separately or together.</p>	<table style="width: 100%; border-collapse: collapse;"> <tr> <td style="text-align: right; padding-right: 5px;">ext.</td> <td style="border: 1px solid black; padding: 2px;">3</td> <td style="border: 1px solid black; padding: 2px;"></td> <td style="border: 1px solid black; padding: 2px;"></td> <td style="text-align: left; padding-left: 5px;">int.</td> <td style="border: 1px solid black; padding: 2px;">rt/rd</td> </tr> <tr> <td style="border-right: 1px solid black; padding-right: 5px;">DA</td> <td style="border: 1px solid black; padding: 2px;">N</td> <td style="border: 1px solid black; padding: 2px;">⊕</td> <td style="border: 1px solid black; padding: 2px;">1</td> <td style="border-right: 1px solid black; padding-right: 5px;"></td> <td style="border: 1px solid black; padding: 2px;">bl/bl</td> </tr> <tr> <td style="border-right: 1px solid black; padding-right: 5px;">N</td> <td style="border: 1px solid black; padding: 2px;">1</td> <td style="border: 1px solid black; padding: 2px;">2</td> <td style="border: 1px solid black; padding: 2px;"></td> <td style="border-right: 1px solid black; padding-right: 5px;"></td> <td style="border: 1px solid black; padding: 2px;">gnge/gnye</td> </tr> <tr> <td style="border-right: 1px solid black; padding-right: 5px;">PE</td> <td style="border: 1px solid black; padding: 2px;">2</td> <td style="border: 1px solid black; padding: 2px;"></td> <td style="border: 1px solid black; padding: 2px;"></td> <td style="border-right: 1px solid black; padding-right: 5px;"></td> <td style="border: 1px solid black; padding: 2px;">bn/bn</td> </tr> <tr> <td style="border-right: 1px solid black; padding-right: 5px;">L</td> <td style="border: 1px solid black; padding: 2px;"></td> <td style="border: 1px solid black; padding: 2px;"></td> <td style="border: 1px solid black; padding: 2px;"></td> <td style="border-right: 1px solid black; padding-right: 5px;"></td> <td style="border: 1px solid black; padding: 2px;">sw/bk</td> </tr> <tr> <td style="border-right: 1px solid black; padding-right: 5px;">DA</td> <td style="border: 1px solid black; padding: 2px;">2</td> <td style="border: 1px solid black; padding: 2px;">3</td> <td style="border: 1px solid black; padding: 2px;"></td> <td style="border-right: 1px solid black; padding-right: 5px;"></td> <td style="border: 1px solid black; padding: 2px;">ws</td> </tr> <tr> <td style="border-right: 1px solid black; padding-right: 5px;">Tast / push</td> <td style="border: 1px solid black; padding: 2px;"></td> <td style="border: 1px solid black; padding: 2px;"></td> <td style="border: 1px solid black; padding: 2px;"></td> <td style="border-right: 1px solid black; padding-right: 5px;"></td> <td style="border: 1px solid black; padding: 2px;">ws</td> </tr> </table>	ext.	3			int.	rt/rd	DA	N	⊕	1		bl/bl	N	1	2			gnge/gnye	PE	2				bn/bn	L					sw/bk	DA	2	3			ws	Tast / push					ws
ext.	3			int.	rt/rd																																							
DA	N	⊕	1		bl/bl																																							
N	1	2			gnge/gnye																																							
PE	2				bn/bn																																							
L					sw/bk																																							
DA	2	3			ws																																							
Tast / push					ws																																							

Mobile App:
Osram BT Control
Osram BT Config

INSTRUCTION

REGIOLUX

Regiolux GmbH
Hellinger Str. 3
D-97486 Königshausen/Bay.
T 09525 89-0
<http://www.regiolux.de>
info@regiolux.de

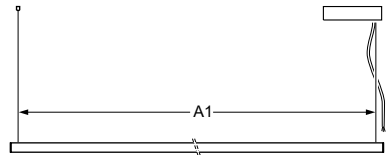

LC 04
LC 05

I max. 10 A

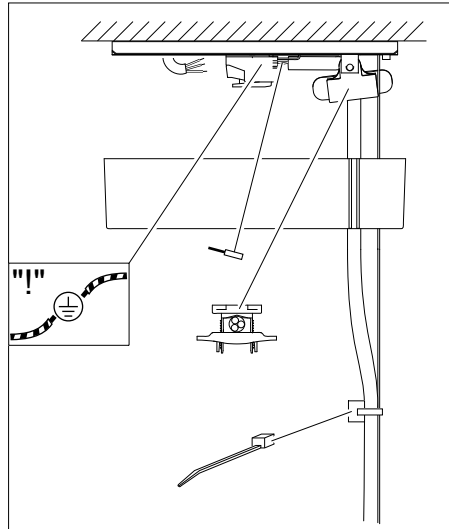

Art-Nr.: 532421 - 10/19

DALIeco Control

- D
- CH
- A
- GB
- E
- F
- B
- I

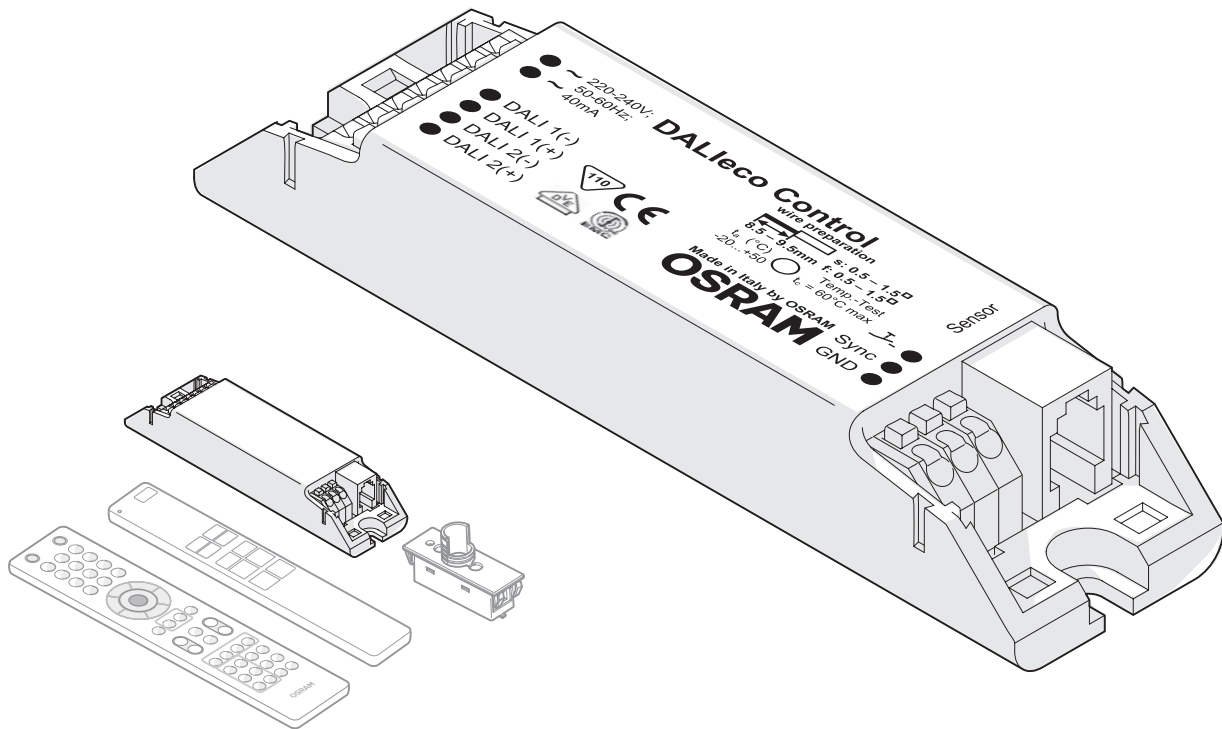

OSRAM



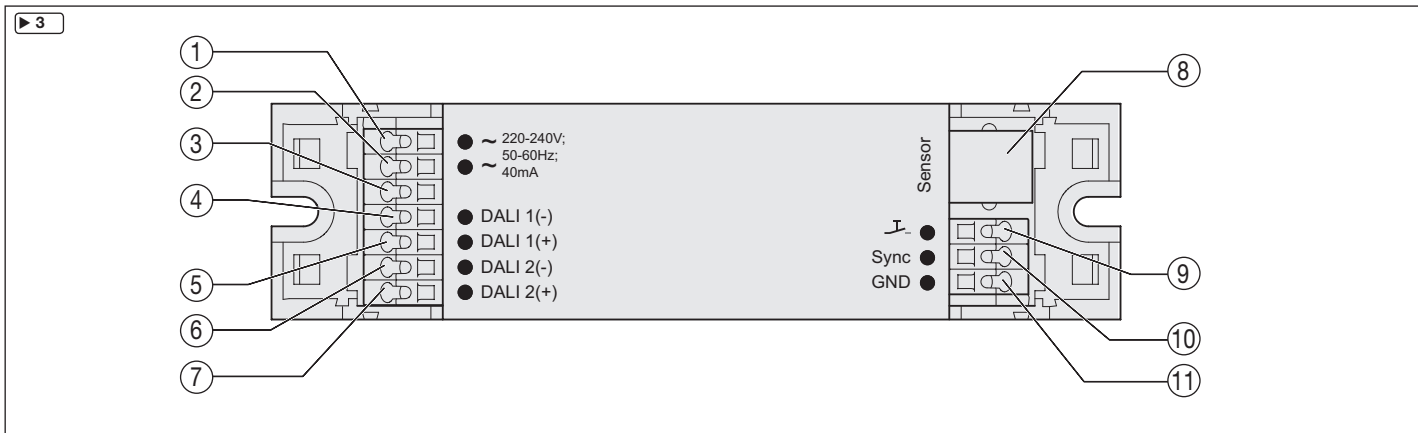
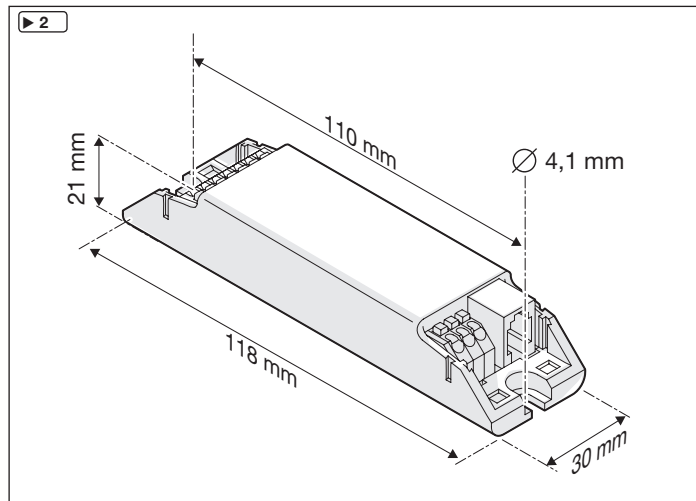
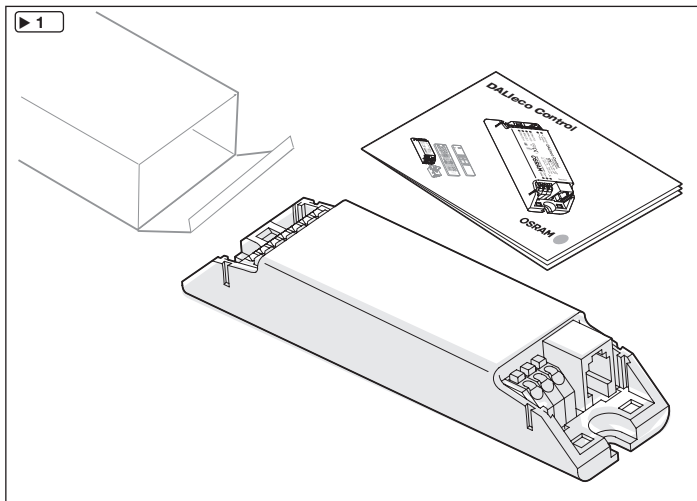

► 4

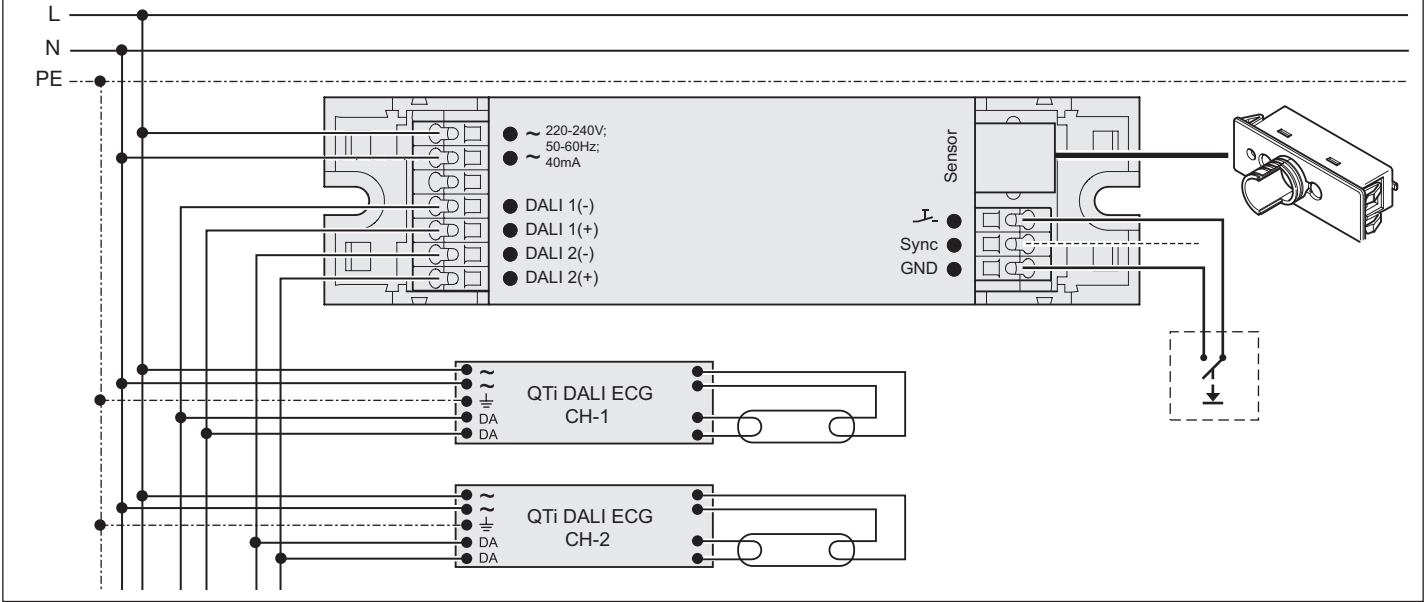

► 5

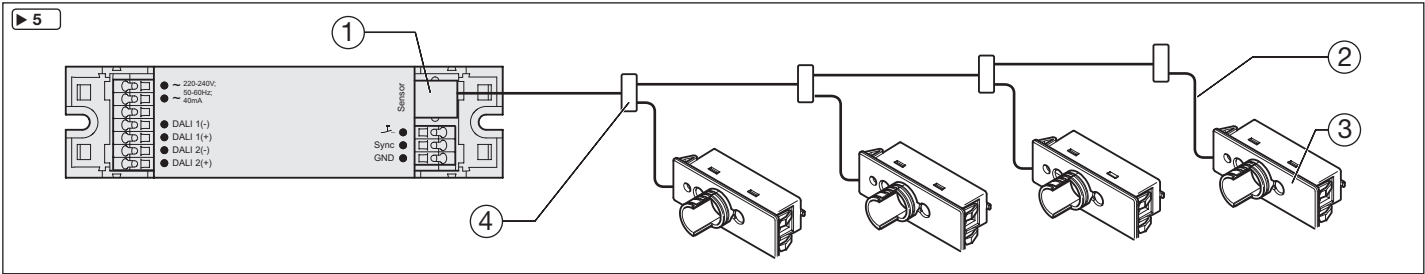

▶ 6

L
N
PE

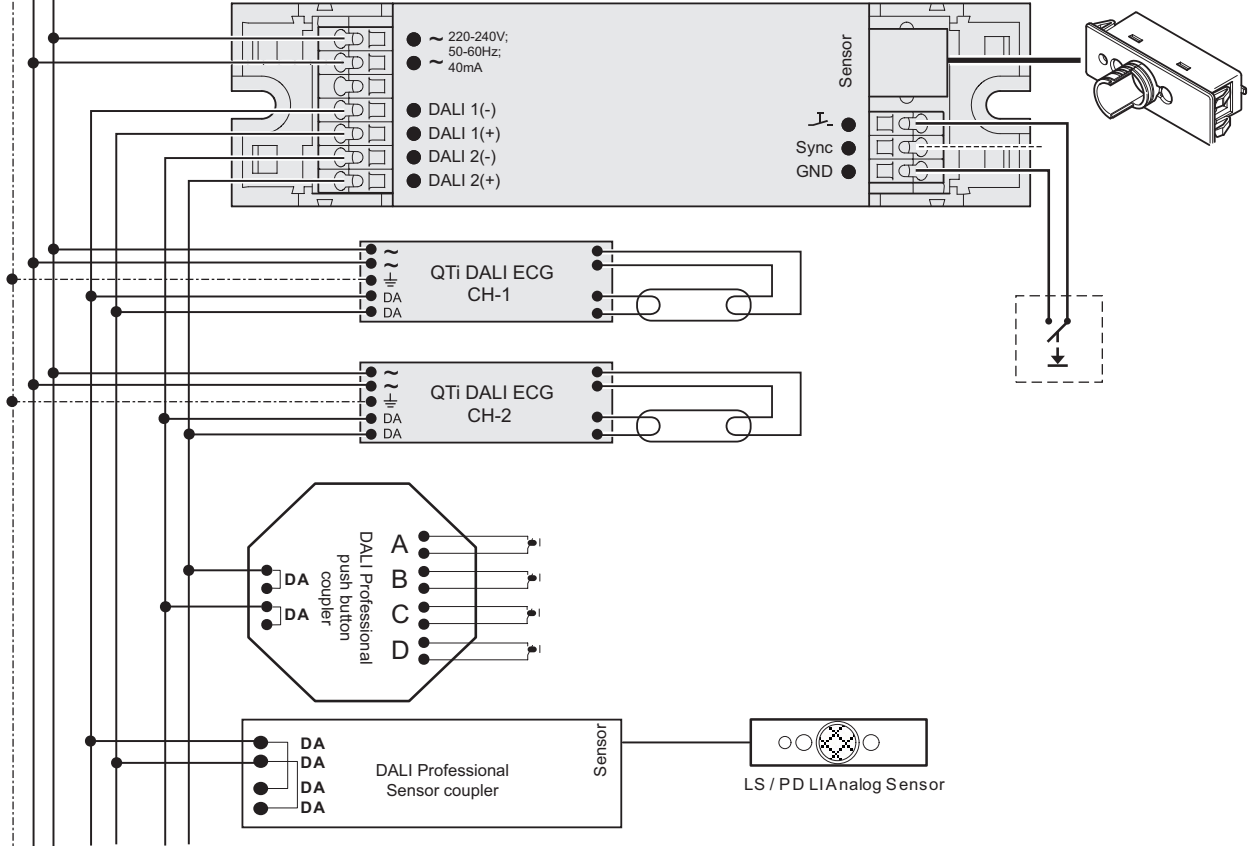

Master Remote

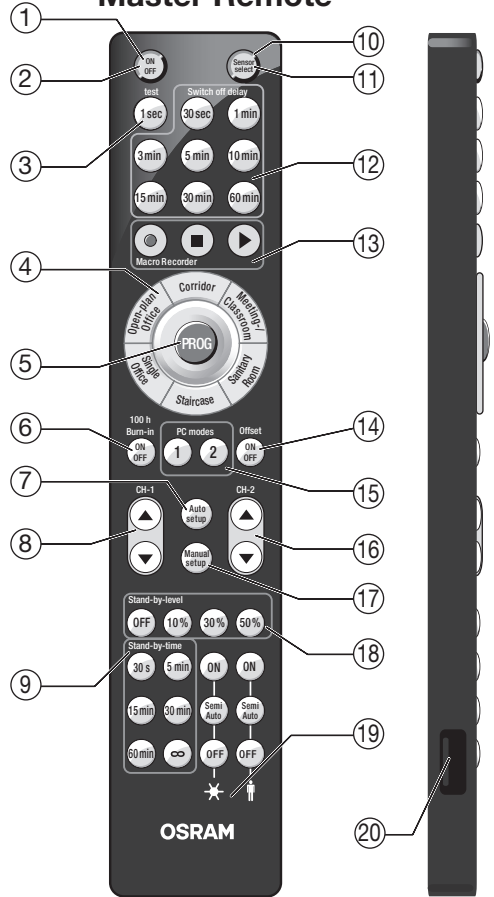

User Remote

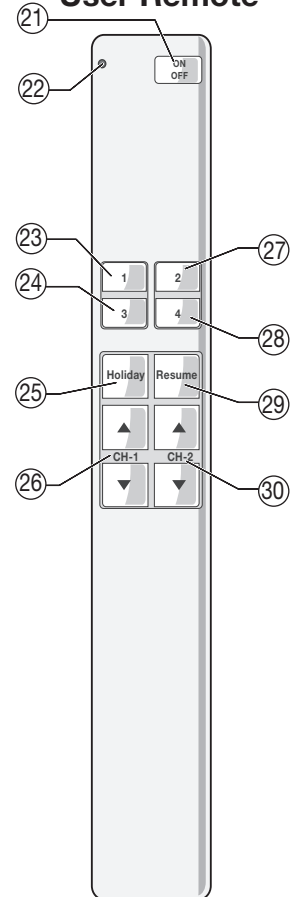

DALieco

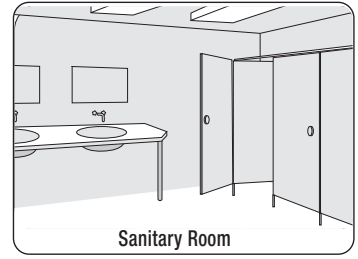
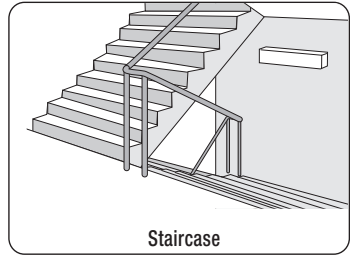
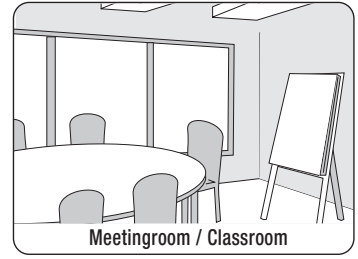
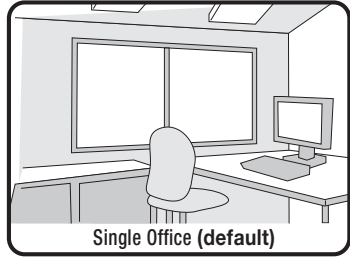
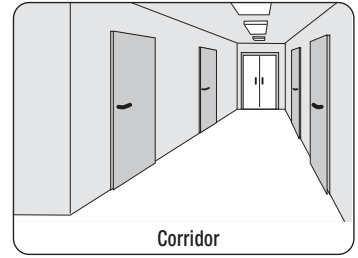
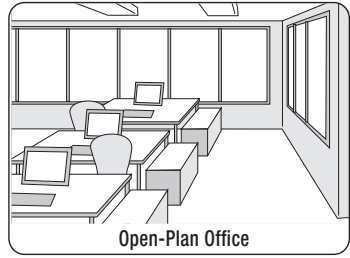
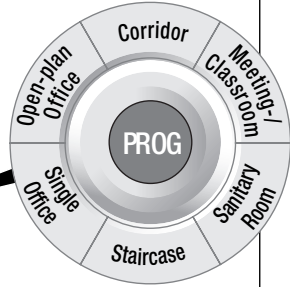
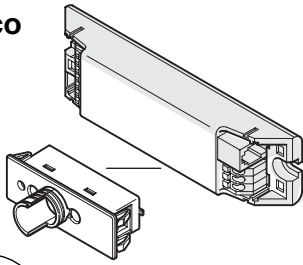

▶ 9

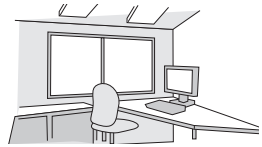
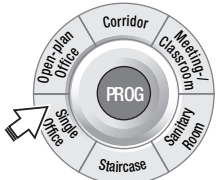

Single Office

(default)

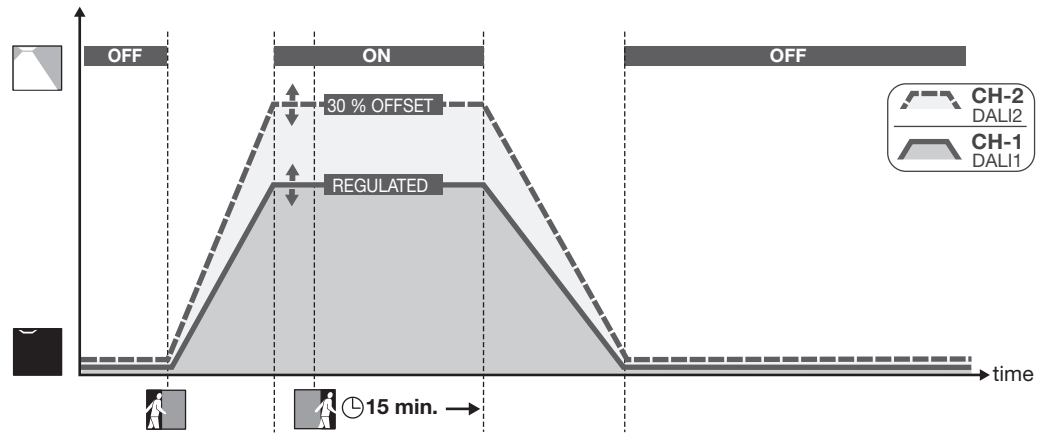

▶ 10

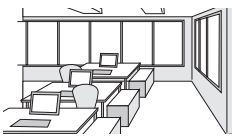

Open Plan Office

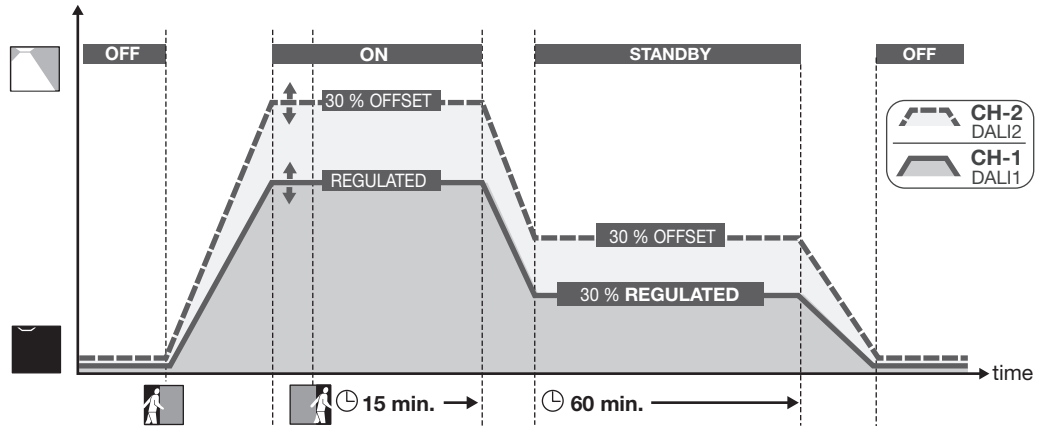

▶ 11

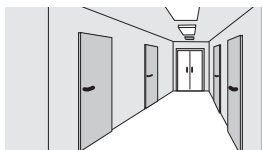
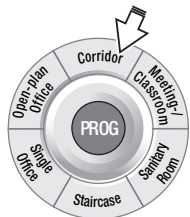

Corridor

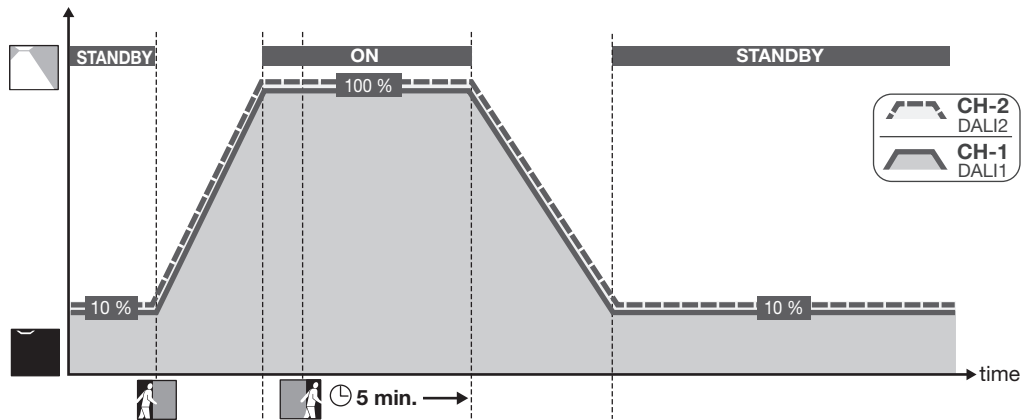

▶ 12

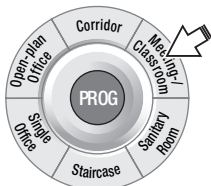

Meetingroom / Classroom

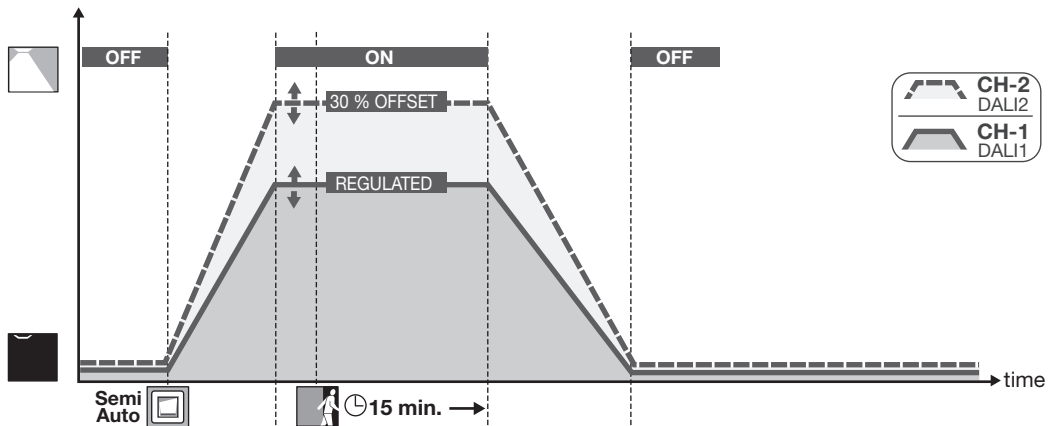

▶ 13

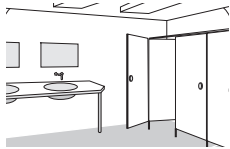
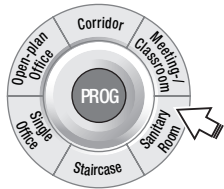

Sanitary Room

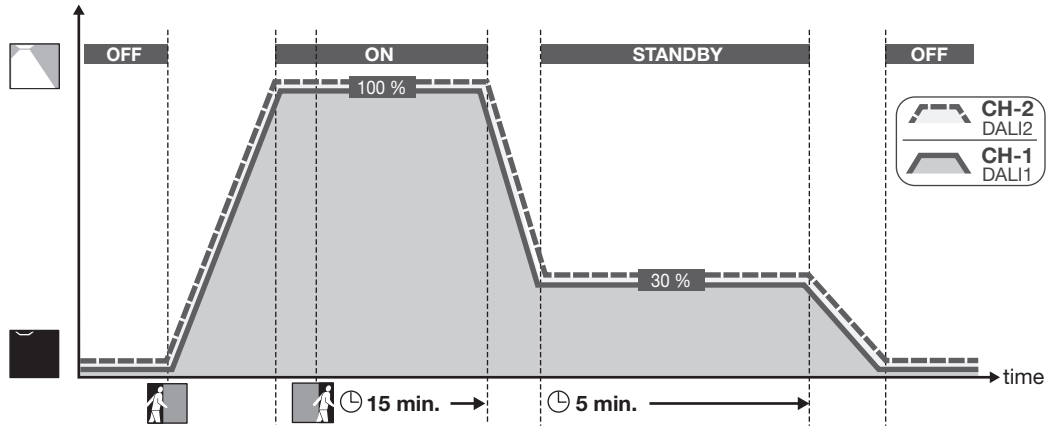



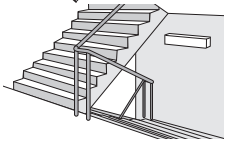



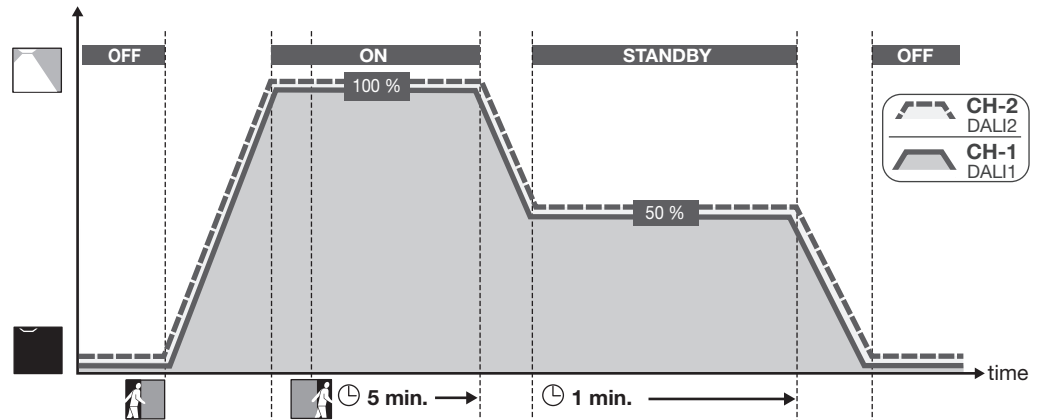







▶ 14



Staircase



Inhaltsverzeichnis

1	Allgemeine Hinweise	11	5.6	Testfunktion	15
1.1	Symbole und Abkürzungen in dieser Anleitung	11	5.7	Stand-by-level	15
1.2	Bestimmungsgemäße Verwendung.....	11	5.8	Stand-by-time.....	16
2	Montage und Installation	11	5.9	 Tageslicht- und  Präsenzfunktionen	16
2.1	Anschlussbelegung der Steuereinheit  3	11	5.10	Offset einstellen	16
2.2	Abmessungen und Montagemaße  2	11	5.11	100 h Burn-in	16
2.3	Anschlusschema elektrische Systemkomponenten  4	11	5.12	Sensor select	17
2.4	Sensor und Vernetzung  5	11	5.13	PC modes.....	17
2.5	Externer Taster  4	11	5.14	Macro Recorder	17
2.6	Anschluss von zusätzlichen Sensoren und Tastern über die DALI-Leitung  6	11	6	System-Bedienung mittels User Remote	17
2.6.1	Einbindung von Tastern über Tasterkoppler.....	12	6.1	Szene-Tasten [1] bis [4]  7	17
2.6.2	Einbindung von Sensoren über Sensorkoppler.....	12	6.2	Taste [Holiday]	17
3	Funktion und externe Komponenten	13	6		
3.1	Grundsätzliche Funktionsweise.....	13	6.3	Taste [Resume]	17
3.2	DALI 1 / DALI 2 Zweikanalsteuerung	13	6.4	Unabhängige Bedienung mehrerer Systeme.....	18
3.3	Externer Taster  4	13	7	Reset	18
3.4	Verhalten nach Netzunterbrechung	13	7.1	System Reset (mittels Master Remote).....	18
4	Bedienung	13	7.2	Reset Master Remote.....	18
4.1	Fernbedienung Master Remote  7 (und  separate Anleitung) ...	13	7.3	Reset User Remote	18
4.2	Fernbedienung User Remote  7 (und  separate Anleitung)	14	8	Technische Daten	18
4.3	System ein-/ausschalten	14			
4.4	Dimmen des Systems.....	14			
5	Schritt-für-Schritt System-Programmierung mittels Master Remote	14			
5.1	Programmiermodus (PROG-Modus)	14			
5.2	Funktionsmodi  8	15			
5.3	Auto setup	15			
5.4	Manual setup	15			
5.5	Switch off delay (Nachlaufzeit)	15			

1 Allgemeine Hinweise

1.1 Symbole und Abkürzungen in dieser Anleitung

- Listenpunkt, Aufzählung
- 1. nummerierte Handlungsschritte mit vorgegebener Reihenfolge
- ▶ 2.2 Verweis auf Abschnitt (z.B. 2.2) bzw. separate Anleitung (dann ohne Ziffern)
- ▶ 14 Bildverweis (z.B. auf Bild 13)







- SP** Abkürzung für „Short Press / Taste kurz drücken“ (<0,5 s)
- LP** Abkürzung für „Long Press / Taste lang drücken“ (>0,5 s)
- VLP** „Very Long Press / Taste sehr lange drücken“ (>10 s)
- DP** „Double Press / kurze Doppelbetätigung“ (jeweils <0,5 s)

 Symbol "INFORMATION / HINWEIS"

1.2 Bestimmungsgemäße Verwendung

Dieses Produkt ist speziell für die Benutzung mit Lichtmanagement-Systemen für Leuchten entwickelt und vorgesehen. Jede andere als die in dieser Anleitung beschriebene Verwendung ist nicht bestimmungsgemäß.

Verwendete Symbolik der Diagramme

	Leuchte ist eingeschaltet: „ON“		Leuchte ist ausgeschaltet: „OFF“
	Automatisches Einschalten der Beleuchtung durch Präsenzerkennung.		Manuelles Einschalten der Beleuchtung durch externen Taster.
 min.	Verzögerungszeit 1: Nach Verlassen des Präsenzerfassungsbereichs.	 min.	Verzögerungszeit 2

2 Montage und Installation

2.1 Anschlussbelegung der Steuereinheit ▶ 3

- (1) Netzanschluss
- (2) Netzanschluss
- (3) nicht belegt
- (4) DALI 1(-)
- (5) DALI 1(+)
- (6) DALI 2(-)
- (7) DALI 2(+)
- (8) Anschluss Sensor (4p4c)
- (9) Eingang externer Taster
- (10) Anschluss Sync (ohne Funktion)
- (11) GND - Bezugspotenzial externer Taster

2.2 Abmessungen und Montagemaße ▶ 2

2.3 Anschlussschema elektrische Systemkomponenten ▶ 4

2.4 Sensor und Vernetzung ▶ 5

Der Sensor ist für die Leuchtenintegration vorgesehen. Installation und Einstellungen am Sensor ▶ separate Anleitung.

Anschluss von max. 4 Sensoren (3) via Y-Connector (4) und Sensorkabel (2) am Sensoranschluss Steuereinheit (1).

Anforderungen an Sensor- und Leuchten-Position:

- Gesamter (zu überwachender) Arbeitsplatz liegt im Überwachungsbereich des Sensors.
- Direkte Bestrahlung des Sensors durch Lichtquellen vermeiden (Fehlmessungen).
- Sensor darf nicht in Bereichen mit Zugluft (Klimaanlage/Lüftung) oder Wärmequellen (Kopierier-/Heizlüfter) installiert werden (Vortäuschung von Personenbewegung).

2.5 Externer Taster ▶ 4

Taster zur manuellen Steuerung/Einstellung. Anschlussbedingungen ▶ 8.

2.6 Anschluss von zusätzlichen Sensoren und Tastern über die DALI-Leitung ▶ 6

Zusätzliche Taster und Sensoren lassen sich über direkt an die beiden DALI-Linien anschließbare Koppler einbinden. Die Funktion ist davon unabhängig, ob der Anschluss über den DALI Kanal 1 oder 2 erfolgt. An jeden DALI Kanal dürfen, zusätzlich zu den 16 DALI EVG, bis zu drei Koppler angeschlossen werden.

D 2.6.1 Einbindung von Tastern über Tasterkoppler

CH
A Taster können über Tasterkoppler ohne weitere Inbetriebnahme an die DALI Leitung angeschlossen werden. Jeder angeschlossene Tasterkoppler verfügt über vier Eingänge (A-D).

Grundeinstellung des Tasterkopplers

In der Grundeinstellung (=Auslieferungszustand) haben alle Eingänge/Taster dieselbe Funktion.

Die Funktion entspricht dem Taster, der direkt am Tastereingang des Steuergerätes angeschlossen ist ► 3.3.

Alternative Funktion / Tastenbelegung der Tasterkoppler

Funktion Taster an Kopplereingang A:

- **SP:** Ein- bzw. Ausschalten DALI CH-1 (Toggle-Funktion)
- **LP:** Aufwärts- bzw. Abwärts-Dimmen DALI CH-1 (Toggle-Funktion)

Funktion Taster an Kopplereingang B:

- **SP:** Ein- bzw. Ausschalten DALI CH-2 (Toggle-Funktion)
- **LP:** Aufwärts- bzw. Abwärts-Dimmen DALI CH-2 (Toggle-Funktion)

Funktion Taster an Kopplereingang C:

- **SP und LP:** Einschalten bzw. Wechsel vom Zustand Standby in den Zustand „ON“

Funktion Taster an Kopplereingang D:

- **SP und LP:** Ausschalten bzw. Wechsel vom Zustand „ON“ in den Zustand „Standby“

Aktivieren der alternativen Funktion /Tastenbelegung der Tasterkoppler

1. Programmiermodus über **LP** auf die „Prog“ Taste (5) der Fernbedienung starten
2. Sensor Select über **LP** auf die Taste (10) der Fernbedienung aktivieren
3. Beliebigen am Tasterkoppler angeschlossenen Taster betätigen
4. Die Beleuchtung dimmt auf 10 % Helligkeit und zeigt so den Beginn des Konfigurationsprozesses an
5. Nach ca. 1 Minute (abhängig von der Anzahl der Koppler) ist der Vorgang abgeschlossen und die Beleuchtung blinkt zwei Mal zur Bestätigung

Rücksetzen des Tasterkopplers auf Grundeinstellung **► 6**

1. Programmiermodus über **LP** auf die „Prog“ Taste (5) der Fernbedienung starten
2. Sensor Select über Taste (10) der Fernbedienung aktivieren
3. Beliebigen am Tasterkoppler angeschlossenen Taster für mehr als 10s betätigen
4. Die Beleuchtung dimmt auf 10 % Helligkeit und zeigt so den Beginn des Rücksetzprozesses an

Nach Abschluss des Rücksetzvorgangs schaltet die Beleuchtung kurz auf 100% , danach wird wieder der ursprüngliche Wert eingestellt.

2.6.2 Einbindung von Sensoren über Sensorkoppler

Sensoren können über Sensorkoppler ohne weitere Inbetriebnahme an die DALI Leitung angeschlossen werden und ermöglichen die Erweiterung des Präsenzerfassungsbereiches.

Die Lichtwerte dieser Sensoren werden nicht ausgewertet.



Wichtiger Hinweis:

Zur Konfiguration der Steuerung mittels Infrarot- Fernbedienung muss mindestens ein Sensor an der Sensor-Schnittstelle des Steuergerätes angeschlossen sein.



Wichtiger Hinweis:

Die Tageslichtregelung nutzt ausschließlich die Lichtwerte der an die Sensor-Schnittstelle angeschlossenen Sensoren.

3 Funktion und externe Komponenten

3.1 Grundsätzliche Funktionsweise

Die Steuereinheit verändert/schaltet die Beleuchtung an Arbeitsplätzen, in Fluren und anderen gemeinsam genutzten Räumen in Abhängigkeit von nutzbarem Tageslicht und Anwesenheit/Bewegung von Personen. Dies wird von Sensoren erfasst. Dadurch wird der Arbeitskomfort erhöht und Energie gespart. Es gibt Funktionsmodi für verschiedene Anwendungen/Szenarien ▶ 8. Diese können individuell angepasst werden ▶ 5.

3.2 DALI 1 / DALI 2 Zweikanalsteuerung

Die Leuchten können nach der elektrischen Installation an DALI 1 (CH-1) und DALI 2 (CH-2) mit identischen Lichtwerten oder mit OFFSET für CH-2 betrieben werden ▶ 5.10.

3.3 Externer Taster ▶ 4

Betätigung eines externen Tasters hat Priorität gegenüber den automatischen Funktionen.

3.4 Verhalten nach Netzunterbrechung

Je nach vorher eingestelltem Funktionsmodus ist das System bei wieder vorhandener Netzspannung in einem voreingestellten Zustand:

Funktionsmodus	Zustand
Single Office	OFF
Open Plan Office	OFF
Corridor	STANDBY
Meeting-/Classroom	LAST STATE
Sanitary Room	STANDBY
Staircase	STANDBY
kein Funktionsmodus gewählt	LAST STATE

4 Bedienung

Beschreibung aller Tasten/LEDs der Master Remote und deren Funktionen, die keine Verwendung der Taste **[PROG]** erfordern, sowie Beschreibung aller Tasten/LED der User Remote und deren Grundfunktionen.

4.1 Fernbedienung Master Remote ▶ 7 (und ▶ separate Anleitung)

Tasten / LEDs / Anschlüsse

- (1) **[ON/OFF]** Beleuchtung ein/aus
- (2) Signalisierung LED 1 (grün/rot/orange)
- (3) **[test]** Testmodus für Einstellung Erfassungsbereich (1 Sekunde Nachlaufzeit)
- (4) **[Funktionsmodi]** Auswahl
- (5) **[PROG]** Programmiermodus ein/aus
- (6) **[100 h Burn-in]** ein/aus
- (7) **[Auto setup]** Aktivierung automatische Sollwertspeicherung
- (8) **[CH-1]** Helligkeit Kanal 1 einstellen (manuell/direkt)
- (9) **[Stand-by-time]** Auswahl Vorgaben STANDBY Zeit
- (10) **[Sensor select]** Auswahl Sensor
- (11) Signalisierung LED 2 (grün/rot/orange)
- (12) **[Switch off delay]** Auswahl Vorgaben Nachlaufzeit
- (13) **[Macro Recorder]** Tastenfolge aufzeichnen/speichern/senden
- (14) **[Offset]** Einstellung OFFSET ein/aus
- (15) **[PC modes]** ohne Funktion
- (16) **[CH-2]** Helligkeit Kanal 2 einstellen (manuell/direkt)
- (17) **[Manual setup]** manuelle Lichtwerteinstellung
- (18) **[Stand-by-level]** Auswahl Vorgaben STANDBY
- (19) **[☒ | 1]** Auswahl Tageslicht-/Präsenzfunktionen ein/halbautomatisch/aus
- (20) Anschluss USB Mini

Signalisierung LEDs

- LED 1 - blinkt schnell bei Signalübertragung (IR) (grün)
- LED 1 - blinkt im „PROG“-Modus (rot)
- LED 1 - leuchtet während USB-Übertragung (orange)
- LED 2 - blinkt im „Sensor Select“-Modus (grün)
- LED 1/LED 2 - leuchten während „Reset“ Master Remote (orange)

D **4.2 Fernbedienung User Remote** 7 **(und separate Anleitung)**

CH
A

Tasten / LED

- (21) **[ON/OFF]** alle Leuchten ein/aus
- (22) Signalisierung LED (grün/rot/orange)
- (23) **[1]** Szenen-Taste 1
- (24) **[3]** Szenen-Taste 3
- (25) **[Holiday]** Aktivierung Holiday-Mode
- (26) **[CH-1]** Helligkeit Kanal 1 einstellen (manuell/direkt)
- (27) **[2]** Szenen-Taste 2
- (28) **[4]** Szenen-Taste 4
- (29) **[Resume]** Wiederaufnahme automatische Tageslichtfunktion
- (30) **[CH-2]** Helligkeit Kanal 2 einstellen (manuell/direkt)

Signalisierung LED (22)

- grün - blinkt schnell bei Signalübertragung (IR)
- rot - blinkt im „Speichern“-Modus
- orange - leuchtet während „Reset“ User Remote

4.3 System ein-/ausschalten



Externer Taster:

1. Externen Taster drücken (SP), um Beleuchtung ein- oder auszuschalten.



Master Remote und User Remote:

1. Taste **[ON/OFF]** drücken (SP), um CH-1 (DALI 1) und CH-2 (DALI 2) ein- bzw. auszuschalten.

4.4 Dimmen des Systems



Externer Taster:

1. Externen Taster drücken (LP), um Helligkeit beider Kanäle jeweils zu erhöhen bzw. zu verringern.



Master Remote und User Remote:

1. Tasten **[CH-1]** oder **[CH-2]** oben/unten gedrückt halten, um Helligkeit der Kanäle DALI 1 und DALI 2 unabhängig voneinander zu erhöhen/verringern.

5 Schritt-für-Schritt System-Programmierung mittels Master Remote

Programmierung bzw. Konfiguration erfolgen mittels Master Remote bzw. direkt am Sensor. Bei Tastendruck Master Remote stets auf den entsprechenden Sensor richten.

Schritt 1	Aktivierung des PROG-Modus	Programmiermodus 5.1
Schritt 2	Auswahl des Funktionsmodus	Funktionsmodi 5.2
Schritt 3	Sollwertvorgabe für Lichtregelung	Auto setup 5.3 oder Manual setup 5.4
Schritt 4	Individuelle Anpassung des gewählten Funktionsmodus	Nachlaufzeit 5.5 Testfunktion 5.6 Stand-by-level 5.7 Stand-by-time 5.8 Tageslicht- und Präsenzfunktionen 5.9
Schritt 5	Lichtwertanpassung für Kanal 2 (CH-2)	Offset 5.10
Schritt 6	Sonderfunktionen	100 h Burn-in 5.11 Sensor select 5.12 PC modes 5.13 Macro Recorder 5.14

5.1 Programmiermodus (PROG-Modus)



1. Taste **[PROG]** drücken (LP), um Programmiermodus zu aktivieren (LED 1 blinkt). CH-1 / CH-2 werden auf den zuletzt gespeicherten Sollwert gedimmt (Default = 80 %).
2. Schritt-für-Schritt Programmierung, erklärt unter 5.1 bis 5.14 (mehrere Funktionen/Einstellungen nacheinander möglich).
3. Taste **[PROG]** drücken (SP), um Einstellungen zu speichern und Programmiermodus zu verlassen.

Wird der PROG-Modus nicht gezielt verlassen, werden Einstellungen nach 60 Sekunden wirksam. Der PROG-Modus wird nach 60 Sekunden ohne Tastenbetätigung automatisch beendet.

5.2 Funktionsmodi ▶ 8

Schaltverhalten der vorkonfigurierten Funktionsmodi: Diagramme ▶ 9 bis ▶ 14.



- Single Office ▶ 9
- Open-plan Office ▶ 10
- Corridor ▶ 11
- Meeting- / Classroom ▶ 12
- Sanitary Room ▶ 13
- Staircase ▶ 14

5.3 Auto setup

Stellt den Sollwert der Lichtregelung auf 80% der maximalen Beleuchtungsstärke ein.

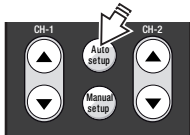

1. Taste [Auto setup] drücken (SP), um Kalibrierung zu starten. Nach 3-minütiger Kalibrierung blinkt die Beleuchtung auf und die automatische Lichtregelung wird gestartet.
Hinweis: Während „AutoSet Up“ keine Einstellungen möglich. „Prog“ Modus wird nach durchgeführtem „AutoSet Up“ automatisch beendet.

5.4 Manual setup

Speichert den Sollwert auf einen beliebigen einstellbaren Wert.

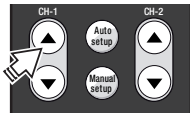

1. Tastenwippe **[CH-1]** unten/oben drücken, um den Sollwert für die Regelung einzustellen.
2. Taste **[Manual setup]** drücken (SP), um aktuelle Beleuchtungsstärke als Sollwert zu speichern (Lampen blinken).

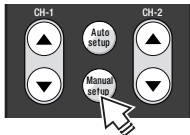

Hinweis:

Ist die Lichtregelung deaktiviert, erhöht das Steuergerät alle 2.000 h Brennstunden den gespeicherten Lichtwert um einen Schritt und kompensiert so die Alterung der Leuchtmittel automatisch. Bei Wechsel des Leuchtmittels muss der Sollwert neu gespeichert werden, um den Vorgang neu zu starten.

5.5 Switch off delay (Nachlaufzeit)

Timer wird bis zum Verlassen des „ON“ Zustandes (Wechsel zu „STANDBY“ oder „OFF“) nach der letzten Präsenzerkennung eingestellt. In den Funktionsmodi „Corridor“, „Staircase“ u. „Sanitary“ wird der Timer auch bei deaktivierter Präsenzerfassung beim Einschalten der Beleuchtung gestartet. Somit ist eine zeitabhängige Steuerung auch bei rein manueller Bedienung möglich.

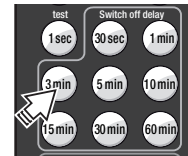

1. Taste [Switch off delay 3 min] drücken (SP), um eine Nachlaufzeit von 3 Minuten für CH-1 und CH-2 einzustellen.

5.6 Testfunktion

Mit der Testfunktion kann der Erfassungsbereich des Sensors überprüft werden

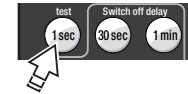

1. Taste **[test]** drücken (SP), um Testfunktion einzuschalten.
2. Taste **[PROG]** drücken (SP), um Test zu starten.
3. Erfassungsbereich betreten:
 - bei Erkennung erfolgt 100% ON,
 - ohne Erkennung nach 1 s zurück auf 1% ON.
4. Ggf. Erfassungsbereich durch Einstellung der Blenden am Sensor ändern und Schritte 3. und 4. so oft wie nötig wiederholen.
5. Nach erfolgreichem Test entweder 60 Sekunden warten oder Taste **[ON/OFF]** oder **[CH-1/CH-2]** vorher drücken (SP), um Testfunktion auszuschalten (Rückkehr zur Normalfunktion).

5.7 Stand-by-level

Helligkeit (%) im STANDBY einstellen bzw. die STANDBY Funktion ausschalten.

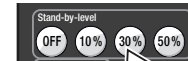

1. Zum Beispiel Taste **[Stand-by-level 30%]** drücken (SP oder LP), um STANDBY für CH-1 einzustellen (CH-2 folgt ggf. mit OFFSET ▶ 5.10).

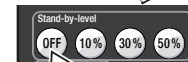

2. Taste **[Stand-by-level OFF]** drücken (SP oder LP), um STANDBY Funktion auszuschalten.

5.8 Stand-by-time

Zeitdauer des STANDBY einstellen bzw. die STANDBY Funktion dauerhaft einschalten.



- Eine der Tasten [Stand-by-time] drücken (SP oder LP), um STANDBY Zeit für CH-1 und CH-2 einzustellen.
Falls [Stand-by-time ∞] gewählt, schaltet die Beleuchtung nie aus.

5.9 Tageslicht- und Präsenzfunktionen

Die Tageslicht- und Präsenzfunktionen können:

- für alle angeschlossenen Sensoren gemeinsam (PROG-Modus ► 5.1)
- für jeden Sensor einzeln (Sensor select ► 5.12) eingestellt werden.

Tageslicht-Funktionen

	Taste [ON]	<ul style="list-style-type: none"> Vollautomatische Tageslichtregelung aktiv
	Taste [Semi Auto]	<ul style="list-style-type: none"> Automatisches Ausschalten bei zuviel Tageslicht Einschalten manuell
	Taste [OFF]	<ul style="list-style-type: none"> Tageslichtregelung ausgeschaltet

Präsenz-Funktionen

	Taste [ON]	<ul style="list-style-type: none"> Präsenzerkennung aktiv
	Taste [Semi Auto]	<ul style="list-style-type: none"> Automatischer Wechsel in „STANDBY“ bzw. „OFF“ nach Ablauf der Nachlaufzeit Einschalten manuell
	Taste [OFF]	<ul style="list-style-type: none"> Präsenzerkennung ausgeschaltet

5.10 Offset einstellen

Der OFFSET (= Abstand von CH-2 zu CH-1) eines bestimmten Funktionsmodus einstellen.

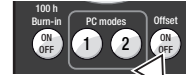

1. Taste [**Offset**] drücken (SP).

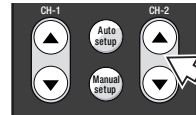

2. Offset wird eingestellt über Tastenwippe [**CH-2**]:

- LP = Grobeinstellung
- SP = Feineinstellung

Der Offset von CH-2 kann betragen:

- min. = Wert von CH-1
- max. = 100 % Helligkeit

3. Taste [**Offset**] drücken (SP), um Einstellung zu speichern.

5.11 100 h Burn-in

Bei Verwendung von Leuchtstofflampen sind stabile Arbeitsweise und maximale Lebensdauer erst nach einer Einbrennphase (100 h bei 100 %) gewährleistet. Während des Einbrennens sind alle Automatik-Funktionen ausgeschaltet, alle Lampen im System leuchten mit 100 %. LEDs aller angeschlossenen Sensoren leuchten permanent rot.

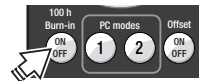

1. Bei Inbetriebnahme bzw. vor regulärer Nutzung des Systems Taste [**100 h Burn-in ON/OFF**] drücken (SP), um den Prozess zu starten.
2. Taste [**100 h Burn-in ON/OFF**] nochmals drücken (SP), um Prozess ggf. vorzeitig zu beenden.

Jeder Funktionsaufruf startet den 100 h Zeitablauf neu.

5.12 Sensor select



1. Taste **[Sensor select]** drücken (LP), um einen Sensor auszuwählen (LED des ausgewählten Sensors blinkt orange).
LED-Anzeige am Sensor:
 - Orange = Sensor selektiert
 - Rot = Präsenzfunktion aktiv
 - Grün = Tageslichtfunktion aktiv
2. Sensor-Einstellungen vornehmen ▶ 5.9.
3. Falls mehrere Sensoren im System, Taste **[Sensor select]** nochmals drücken (SP), um nächsten Sensor zu selektieren.
4. Taste **[Sensor select]** drücken (LP), um Sensor-Einstellungen zu speichern oder Taste **[PROG]** drücken (SP).

5.13 PC modes



Ohne Funktion.

5.14 Macro Recorder



Ohne Funktion.

6 System-Bedienung mittels User Remote

Bei Tastendruck User Remote stets auf den entsprechenden Sensor richten.

6.1 Szene-Tasten [1] bis [4] ▶ 7

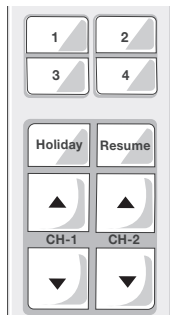

- **Szene aufrufen:** Auswahl der gespeicherten Licht-Szene durch Tastendruck (SP).
- **Szene speichern:** eine über **[CH-1]** und/oder **[CH-2]** manuell veränderte Beleuchtungsstärke kann durch Tastendruck (LP) auf die jeweilige Szene-Taste gespeichert werden (System blinkt zur Bestätigung).
- **Szene-Speicherung sperren oder wieder freigeben:**
 1. - Tasten **[Holiday]**+**[CH-2 ▲]** zeitgleich drücken (VLP) (LED rot blinkt).
 2. - Taste **[1]** drücken (SP), um Szene-Speicherung zu sperren (LED leuchtet rot für drei Sekunden)
 - Taste **[2]** drücken (SP) drücken (SP), um Szene-Speicherung freizugeben (LED leuchtet grün für drei Sekunden).

6.2 Taste [Holiday]

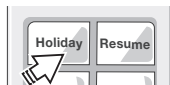

Temporäre Deaktivierung der Präsenzerkennung mittels Tastendruck (SP), Sensor-LED bleibt dauerhaft rot.
Re-Aktivierung mittels Tasten **[ON/OFF]**, Szene-Tasten **[1]** bis **[4]** und **[CH-1]/[CH-2]** möglich.

6.3 Taste [Resume]

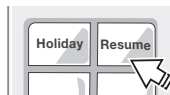

Wiederaufnahme der automatischen Lichtsteuerfunktion mittels Tastendruck (SP). Bei Funktionsmodi ohne Lichtregelung hat diese Taste keine Funktion.

D
CH
A

6.4 Unabhängige Bedienung mehrerer Systeme

Anlernen der User Remote auf einen bestimmten, ausgewählten Empfänger, um eine unabhängige Bedienung mehrerer Systeme (maximal 15) im gleichen Raum zu ermöglichen.



1. Tasten **[CH-1 ▼]** + **[CH-2 ▼]** zeitgleich drücken (VLP), um individuelle Programmierung zu starten (LED rot blinkt).
2. Nummernblock aktivieren (Werkseinstellung = 16):
 - Nummernblock 1-4: Taste **[1]** drücken (SP).
 - Nummernblock 5-8: Taste **[2]** drücken (SP).
 - Nummernblock 9-12: Taste **[3]** drücken (SP).
 - Nummernblock 13-16: Taste **[4]** drücken (SP).
3. Systemnummer programmieren:
 - Taste **[1]**, **[2]**, **[3]** oder **[4]** drücken (SP) für die zu programmierende Systemnummer (Werkseinstellung = 16) (LED grün blink zwei mal und System blinkt zur Bestätigung).

--> Beispiel: Systemnummer 10 programmieren:

1. Tasten **[CH-1 ▼]** + **[CH-2 ▼]** zeitgleich drücken (VLP) (LED rot blinkt).
2. Taste **[3]** drücken (SP), um Nummerblock 9-12 zu aktivieren.
3. Taste **[2]** drücken (SP), um Systemnummer 10 zu programmieren (LED grün blink zwei mal und System blinkt zur Bestätigung).

7 Reset

7.1 System Reset (mittels Master Remote)

1. Taste **[PROG]** drücken (LP), um Programmiermodus zu starten (LED1 blinkt).
2. **[Single Office]** drücken (SP), um default Funktionsmodus einzustellen (LED1 blinkt schnell).
3. Taste **[PROG]** drücken (SP), um Programmiermodus zu verlassen.

7.2 Reset Master Remote

1. Taste **[PROG]** drücken (LP), um Programmiermodus zu starten (LED1 blinkt).
2. Gleichzeitiges Drücken (VLP) von **[Corridor]** und **[Staircase]** (LED2 blinkt).
3. Taste **[PROG]** drücken (LP) – (LED1 und LED2 leuchten orange für 3 Sekunden).

7.3 Reset User Remote

1. Gleichzeitiges Drücken (VLP) von **[CH-1 ▲]** und **[Resume]** (LED rot blinkt).
2. Taste **[4]** drücken (SP) – (LED leuchtet orange für 3 Sekunden).

8 Technische Daten

Netzanschluss	220 – 240 V AC 50-60 Hz
Eingang Taster	Potenzialfreie Schließerkontakte, max. Leitungslänge 50 m
Last(steuere)ausgänge DA1+/- / DA2+/-	nach IEC 62386 dto.
Steuerstrom	max. 64 mA (je Kanal) max. 96 mA (Summe beider Kanäle) max. Kabellänge 100 m (je Kanal)
Anschluss Sensorik	DALIeco LS/PD LI = max. 4x DALIeco LS/PD LI HF = max. 1x max. Leitungslänge 25 m, bei Verlängerung/Kürzung Kontaktbelegung 1:1 sicherstellen
Leistungsaufnahme	0,2 W - 3,0 W (abhängig von EVG-/Sensoranzahl)
Umgebungstemperatur	-20 °C bis +50 °C (Betrieb)
Schutzart	IP20
Schutzklasse	II, Schutzisolierung
Konformität	CE















Wichtiger Hinweis:



Wenn es nicht möglich ist, die Sensorleitungen und Tasterleitungen der direkt am Steuergerät angeschlossenen Sensoren und Tastern getrennt von Netz- und Lampenleitungen zu verlegen, dann empfehlen wir, die Sensoren und Taster über die DALI Leitung anzubinden.

DALleco Control - Installation and Operation

GB

Contents

1	General.....	21
1.1	Symbols and abbreviations in these instructions.....	21
1.2	Intended use.....	21
2	Mounting and installation	21
2.1	Connection allocation in the control unit  3	21
2.2	Dimensions and mounting dimensions  2	21
2.3	Connection diagram for electrical system components  4	21
2.4	Sensor and networking  5	21
2.5	External push-button  4	21
2.6	Connection of additional sensors and push-buttons via the DALI line  6	22
2.6.1	Integration of push-buttons via push-button coupler.....	22
2.6.2	Integration of sensors via sensor coupler.....	22
3	Function and external components.....	23
3.1	Fundamental operating principle.....	23
3.2	DALI 1 / DALI 2 twin-channel control.....	23
3.3	External push-button  4	23
3.4	Behavior after mains interruption	23
4	Operation.....	23
4.1	Master Remote remote control  7 (and  separate instructions)	23
4.2	User Remote remote control  6 (and  separate instructions).....	24
4.3	Switch system on/off.....	24
4.4	Dimming the system.....	24
5	Step-by-step system programming using Master Remote.....	24
5.1	Programming mode (PROG mode)	24
5.2	Function modes  8	25
5.3	Auto setup	25
5.4	Manual setup	25
5.5	Switch off delay (overrun time)	25
5.6	Test function	25
5.7	Stand-by level.....	25
5.8	Stand-by-time.....	26

5.9	 Daylight and  motion-sensing functions	26
5.10	Setting offset	26
5.11	100 h Burn-in.....	26
5.12	Sensor select.....	26
5.13	PC modes.....	27
5.14	Macro Recorder	27
6	System operation using User Remote	27
6.1	Scene push-buttons [1] to [4]  7	27
6.2	Push-button [Holiday].....	27
6.3	Push-button [Resume]	27
6.4	Independent operation of several systems	28
7	Reset.....	28
7.1	System reset (using Master Remote)	28
7.2	Reset Master Remote.....	28
7.3	Reset User Remote	28
8	Technical data	28

1 General

1.1 Symbols and abbreviations in these instructions

- Bullet point, listing
- 1. Numbered steps with stipulated sequence
- ▶ 2.2 Cross-reference to Section (e.g. 2.2) or separate instructions (but then without figures)
- ▶ 14 Figure cross-reference (e.g. to Fig. 13)

SP Abbreviation for "Short Press" (<0.5 sec.)

LP Abbreviation for "Long Press" (>0.5 sec)

VLP "Very Long Press" (>10 sec)







DP "Double Press" (each <0.5 sec)

 Symbol "INFORMATION"

1.2 Intended use

This product has been developed and is intended specifically for use with light management systems for luminaires. Any other use other than that described in these instructions is not intended.

Symbols used in the diagrams

	Luminaire is switched on: "ON"		Luminaire is switched off: "OFF"
	Automatic switching on of the lighting by motion detection.		Manual switching on of the lighting by external switch.
	Delay period 1: After leaving the motion detection area.		Delay period 2

2 Mounting and installation

2.1 Connection allocation in the control unit ▶ 3

- (1) Mains connection
- (2) Mains connection
- (3) Spare
- (4) DALI 1(-)
- (5) DALI 1(+)
- (6) DALI 2(-)
- (7) DALI 2(+)
- (8) Sensor connection (4p4c)
- (9) Input external push-button
- (10) Sync connection (no function)
- (11) GND - Reference potential external push-button

2.2 Dimensions and mounting dimensions ▶ 2

2.3 Connection diagram for electrical system components ▶ 4

2.4 Sensor and networking ▶ 5

The sensor is provided for luminaire integration. Installation and settings on sensor ▶ separate instructions.

Connection of max. 4 sensors (3) via Y-connector (4) and sensor cable (2) to sensor connection on control unit (1).

Requirements for sensor and luminaire position:

- Entire workplace (to be monitored) is within monitoring area of the sensor.
- Avoid direct radiation of the sensor by light sources (incorrect measurements).
- The sensor must not be installed in areas where there is a draft (air conditioning/ventilation) or heat sources (photocopier/hot air blower) (incorrect sensing of persons moving).

2.5 External push-button ▶ 4

Push-button for manual control/setting. Connection conditions ▶ 8.

2.6 Connection of additional sensors and push-buttons via the DALI line ▶ 6

Additional push-buttons and sensors can be integrated using coupling units that can be connected directly to the two DALI lines. The function does not depend on whether connection is via DALI channel 1 or 2. Up to three couplers can be connected to each DALI channel, in addition to the 16 DALI ECGs.

2.6.1 Integration of push-buttons via push-button coupler

Push-buttons can be connected via push-button couplers without additional commissioning to the DALI line. Each connected push-button coupler has four inputs (A-D).

GB

Basic setting of the push-button coupler

In the basic setting (=factory setting) all inputs/push-buttons have the same function.

The function corresponds to the push-button that is directly connected to the push-button input of the control unit ► 3.3.

Alternative function / push-button allocation of the push-button coupler

Push-button function on coupler input A:

- **SP:** Switch on and off DALI CH-1 (toggle function)
- **LP:** Dimming up and down DALI CH-1 (toggle function)

Push-button function on coupler input B:

- **SP:** Switch on and off DALI CH-2 (toggle function)
- **LP:** Dimming up and down DALI CH-2 (toggle function)

Push-button function on coupler input C:

- **SP and LP:** Switching on or changing from condition Standby to condition "ON"

Push-button function on coupler input D:

- **SP and LP:** Switching off or changing from condition "ON" to condition "Standby"

Activating the alternative function / push-button allocation of the push-button coupler

1. Start the programming mode via **LP** on "Prog" button (5) on the remote control
2. Activate Sensor Select via **LP** on push-button (10) on the remote control
3. Actuate any of the push-buttons connected to the push-button coupler
4. The lighting dims to 10% brightness, thus indicating that the configuration process has begun
5. The process is complete after approx. 1 minute (depending on the number of couplers) and the lighting flashes twice in confirmation

Resetting the push-button coupler to basic setting ► 6

1. Start the programming mode via **LP** on "Prog" button (5) on the remote control
2. Activate Sensor Select via push-button (10) on the remote control
3. Actuate any of the push-buttons connected to the push-button coupler for more than 10 secs.
4. The lighting dims to 10% brightness, thus indicating that the reset process has begun

After the reset process is complete, the lighting briefly switches to 100% and then the original value is set again.

2.6.2 Integration of sensors via sensor coupler

Sensors can be connected to the DALI line via the sensor coupler without additional commissioning and allow extension of the motion detection range.

The light values of these sensors are not evaluated.



Important note:

For configuration of the control using infrared remote control, at least one sensor must be connected to the sensor interface on the control unit.



Important note:

The daylight adjustment uses exclusively the light values of the sensors connected to the sensor interface.

3 Function and external components

3.1 Fundamental operating principle

The control unit changes/switches the lighting at workplaces, in corridors and other common rooms depending on the usable daylight and the presence/motion of persons. This is recorded by sensors. This increases working comfort and saves energy. There are function modes for various applications/scenarios ▶ 8.

These can be adapted individually ▶ 5.

3.2 DALI 1 / DALI 2 twin-channel control

The luminaires can be operated with identical light values or with OFFSET for CH-2 after electrical installation to the DALI 1 (CH-1) and DALI 2 (CH-2) ▶ 5.10.

3.3 External push-button ▶ 4

Actuation of an external push-button has priority over automatic functions.

3.4 Behavior after mains interruption

Depending on the set function mode, the system is in preset condition when mains voltage is restored:

Operating mode	Condition
Single Office	OFF
Open Plan Office	OFF
Corridor	STANDBY
Meeting room/classroom	LAST STATE
Sanitary Room	STANDBY
Staircase	STANDBY
No operating mode selected	LAST STATE

4 Operation

Description of all push-buttons/LEDs of the Master Remote and its functions that do not require use of the [PROG] push-button, and description of all push-buttons/LEDs of the User Remote and their basic functions.

GB

4.1 Master Remote remote control ▶ 7 (and ▶ separate instructions)

Push-buttons / LEDs / connections

- (1) [ON/OFF] Lighting on/off
- (2) Signalization LED 1 (green/red/orange)
- (3) [test] Test mode for setting detection range (1 second delay time)
- (4) [Function modes] selection
- (5) [PROG] Programming mode on/off
- (6) [100 h Burn-in] on/off
- (7) [Auto setup] Activation of automatic set value saving
- (8) [CH-1] Setting brightness on channel 1 (manual/direct)
- (9) [Stand-by-time] Selection of STANDBY time defaults
- (10) [Sensor select] Sensor selection
- (11) Signalization LED 2 (green/red/orange)
- (12) [Switch off delay] Selection of delay time defaults
- (13) [Macro Recorder] Recording/saving/sending push-button sequence
- (14) [Offset] Setting OFFSET on/off
- (15) [PC modes] No function
- (16) [CH-2] Setting brightness on channel 2 (manual/direct)
- (17) [Manual setup] Manual light value setting
- (18) [Stand-by-level] Selection of STANDBY defaults
- (19) [X] [I] Selection of daylight/motion sensor functions on/semi-automatic/off
- (20) Connection USB mini

Signalization LEDs

- LED 1 - flashes rapidly during signal transfer (IR) (green)
- LED 1 - flashes in "PROG" mode (red)
- LED 1 - lights up during USB transmission (orange)
- LED 2 - flashes in "Sensor Select" mode (green)
- LED 1/LED 2 - lights up during "Reset" Master Remote (orange)

4.2 User Remote remote control 7 (and ► separate instructions)

Push-buttons / LED

- (21) **[ON/OFF]** All luminaires on/off
- (22) LED signalization (green/red/orange)
- (23) **[1]** Scene push-button 1
- (24) **[3]** Scene push-button 3
- (25) **[Holiday]** Activation of Holiday Mode
- (26) **[CH-1]** Setting brightness on Channel 1 (manual/direct)
- (27) **[2]** Scene push-button 2
- (28) **[4]** Scene push-button 4
- (29) **[Resume]** Resume automatic daylight function
- (30) **[CH-2]** Setting brightness on Channel 2 (manual/direct)

LED signalization (22)

- green - flashes rapidly during signal transfer (IR)
- red - flashes in "Saving" mode
- orange - lights up during "Reset" User Remote

4.3 Switch system on/off



External push-button:

1. Press external push-button (SP) to switch the lighting on or off.



Master Remote and User Remote:

1. Press **[ON/OFF]** push-button (SP) to switch CH-1 (DALI 1) and CH-2 (DALI 2) on and off.

4.4 Dimming the system



External push-button:

1. Press external push-button (LP) to increase or decrease the brightness of both channels.



Master Remote and User Remote:

1. Hold down push-button **[CH-1]** or **[CH-2]** top/bottom to increase/reduce the brightness of the channels DALI 1 and DALI 2 independently of each other.

5 Step-by-step system programming using Master Remote

Programming or configuration is carried out using Master Remote or directly at the sensor.

When pressing the Master Remote push-button always point to the relevant sensor.

Step 1	Activating the PROG mode	Programming mode ► 5.1
Step 2	Selection of functioning mode	Function modes ► 5.2
Step 3	Set value default for light regulation	Auto setup ► 5.3 or manual setup ► 5.4
Step 4	Individual adjustment of the selected function mode	Delay time ► 5.5 Test function ► 5.6 Stand-by-level ► 5.7 Stand-by-time ► 5.8 Daylight and motion functions ► 5.9
Step 5	Light value adjustment for Channel 2 (CH-2)	Offset ► 5.10
Step 6	Special functions	100 h burn-in ► 5.11 Sensor select ► 5.12 PC modes ► 5.13 Macro recorder ► 5.14

5.1 Programming mode (PROG mode)



1. Press push-button **[PROG]** (LP) to activate programming mode (LED 1 flashes). CH-1/CH-2 are dimmed down to the last saved set value (default = 80 %).
2. Step-by-step programming, explained under ► 5.1 to ► 5.14 (several functions/settings possible one after the other).
3. Press push-button **[PROG]** (SP), to save settings and to exit programming mode.

If the PROG mode is not specifically exited, the settings become effective after 60 secs. The PROG mode terminates automatically after 60 secs. without push-button actuation.

5.2 Function modes ▶ 8

Switching behavior of the preconfigured function modes: Diagrams ▶ 9 to ▶ 14.



- Single Office ▶ 9
- Open-plan office ▶ 10
- Corridor ▶ 11
- Meeting room/classroom ▶ 12
- Sanitary room ▶ 13
- Staircase ▶ 14

5.3 Auto setup

Sets the target value of light regulation to 80% of maximum lighting intensity.

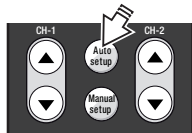

1. Press the push-button [Auto setup] (SP) to start the calibration. After 3 minutes calibration, the lighting flashes and automatic light regulation starts.
Note: No settings can be made during "Auto setup". "Prog" mode is terminated automatically after "Auto setup" has been carried out.

5.4 Manual setup

Saves the set value to any adjustable value.

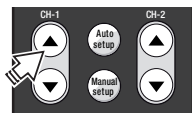

1. Press the push-button rocker [CH-1] top/bottom to set the target value for control.

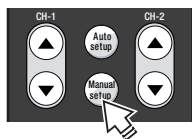

2. Press the push-button [Manual setup] (SP), to save the current lighting intensity as the set value (lamps flash).

i Note:

If the light control system is activated, the control unit increases the saved light value by one step automatically every 2000 operating hours, thus compensating for the aging of the light source. If the light source is changed, the set value needs to be saved again to restart the process.

5.5 Switch off delay (overrun time)

The timer is set until exiting the "ON" condition (change to "STANDBY" or "OFF") according to the last detection of motion. In the function modes "Corridor", "Staircase" and "Sanitary", the timer is started by switching on the lighting, even if the motion sensing is deactivated. This permits time-dependent control also with purely manual operation.

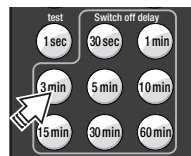

1. Press push-button [Switch off delay 3 min] (SP) to set an overrun period of 3 minutes for CH-1 and CH-2.

5.6 Test function

The detection range of the sensor can be checked using the test function.

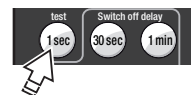

1. Press push-button [test] (SP) to switch on the test function.
2. Press push-button [PROG] (SP) to start the test.
3. Enter the detection area:
 - with detection 100% ON,
 - without detection after 1 sec. back to 1% ON.
4. If necessary, adjust the detection range by setting the screens on the sensor and repeat steps 3 and 4 as often as necessary.
5. After completing the test, either wait 60 seconds or press the push-button [ON/OFF] or [CH-1/CH-2] (SP) to switch off the test function (return to normal function).

5.7 Stand-by level

Set the brightness (%) in STANDBY or switch the STANDBY function off.

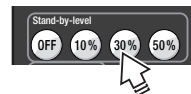

1. For example, press push-button [stand-by level 30%] (SP or LP) to set STANDBY for CH-1 (CH-2 follows, if necessary, with OFFSET ▶ 5.10).

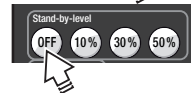

2. Press push-button [stand-by level OFF] (SP or LP) to switch STANDBY function off.

5.8 Stand-by-time

Set the duration of STANDBY or switch the STANDBY function to continuous.



- Press one of the push-buttons [Stand-by-time] (SP or LP) to set STANDBY time for CH-1 and CH-2.
If [Stand-by-time ∞] is selected, the lighting never switches off.

5.9 Daylight and motion-sensing functions

The daylight and motion-sensing functions can be set for:

- all connected sensors together (PROG mode ▶ 5.1)
- each sensor individually (sensor select ▶ 5.12).

Daylight functions

	Push-button [ON]	<ul style="list-style-type: none"> • Fully automatic daylight control active
	Push-button [Semi Auto]	<ul style="list-style-type: none"> • Automatic switch-off with too much daylight • Manual switch-on
	Push-button [OFF]	<ul style="list-style-type: none"> • Daylight control switched off

Motion-sensing functions

	Push-button [ON]	<ul style="list-style-type: none"> • Motion-detection active
	Push-button [Semi Auto]	<ul style="list-style-type: none"> • Automatic change to "STANDBY" or "OFF" after overrun time has expired • Manual switch-on
	Push-button [OFF]	<ul style="list-style-type: none"> • Motion-detection switched off

5.10 Setting offset

Setting the OFFSET (=distance from CH-2 to CH-1) of a specific function mode.

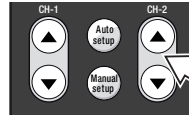

1. Press push-button **[Offset]** (SP).
2. Offset is set using the push-button rocker **[CH-2]**:
 - LP = Coarse setting
 - SP = Fine setting
 The offset of Ch-2 can be:
 - min. = value of CH-1
 - max. = 100 % brightness
3. Press push-button **[Offset]** (SP) to save the setting.

5.11 100 h Burn-in

When using fluorescent lamps, stable operation and maximum lifespan are only assured after a burn-in phase (100 h at 100%). The automatic functions are switched off during burn-in, all lamps in the system illuminate at 100%.

LEDs on all connected sensors light up red continuously.



1. During commissioning or before regular use of the system press the push-button **[100 h Burn-in ON/OFF]** (SP) to start the process.
2. Press push-button **[100 h Burn-in ON/OFF]** again (SP) to end the process prematurely.

Each function call-up restarts the 100 h time period.

5.12 Sensor select



1. Press push-button **[Sensor select]** (LP) to select a sensor (LED on selected sensor flashes orange).
LED display on sensor:
 - Orange = Sensor selected
 - Red = Motion detection active
 - Green = Daylight function active
2. Implementing sensor settings ► 5.9.
3. If several sensors are in the system, press the push-button **[Sensor select]** (SP) again to select the next sensor.
4. Press push-button **[Sensor select]** (LP) to save sensor settings or press push-button **[PROG]** (SP).

5.13 PC modes



No function.

5.14 Macro Recorder



No function.

6 System operation using User Remote

When pressing the User Remote push-button always point to the relevant sensor.

6.1 Scene push-buttons [1] to [4] ► 7

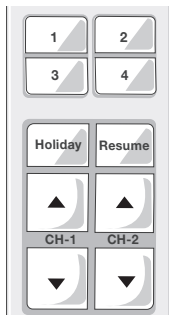

- **Calling up scene:** Selection of the saved light scene by push-button (SP).
- **Saving scene:** a manually changed lighting intensity using **[CH-1]** and/or **[CH-2]** can be saved to the specific scene button by pressing the push-button (LP) (system flashes in confirmation).
- **Blocking or releasing scene saving:**
 1. - Simultaneously press push-buttons **[Holiday]**+**[CH-2 ▲]** (VLP) (LED flashes red).
 2. - Press push-button **[1]** (SP) to block scene saving (LED lights up red for three seconds)
 - Press push-button **[2]** (SP) to release scene saving (LED lights up green for three seconds).

GB

6.2 Push-button [Holiday]

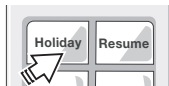

Temporary deactivation of motion-detecting by pressing a push-button (SP), sensor LED lights up red continuously. Reactivation using push-buttons **[ON/OFF]**, scene push-buttons **[1]** to **[4]** and **[CH-1]/[CH-2]** is possible.

6.3 Push-button [Resume]

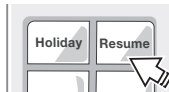

Restarting of the automatic light control function by push-button (SP). For function modes without light control this push-button has no function.

6.4 Independent operation of several systems

Teaching of the User Remote to a specific selected receiver in order to permit independent operation of several systems (maximum 15) in the same room.

GB



1. Simultaneously press push-buttons **[CH-1 ▼]** + **[CH-2 ▼]** (VLP) to start individual programming (LED flashes red).
2. Activating number block (factory setting = 16):
 - Number block 1-4: Press push-button **[1]** (SP).
 - Number block 5-8: Press push-button **[2]** (SP).
 - Number block 9-12: Press push-button **[3]** (SP).
 - Number block 13-16: Press push-button **[4]** (SP).
3. Programming system number:
 - Press push-button **[1]**, **[2]**, **[3]** or **[4]** (SP) for the system number to be programmed (factory setting = 16) (LED flashes green twice and system flashes in confirmation).

--> Example: Programming system number 10:

1. Simultaneously press push-buttons **[CH-1 ▼]** + **[CH-2 ▼]** (VLP) (LED flashes red).
2. Press push-button **[3]** (SP) to activate number block 9-12.
3. Press push-button **[2]** (SP) to program system number 10 (LED flashes green twice and system flashes in confirmation).

7 Reset

7.1 System reset (using Master Remote)

1. Press push-button **[PROG]** (LP) to start programming mode (LED1 flashes).
2. Press **[Single Office]** (SP) to set default function mode (LED1 flashes rapidly).
3. Press push-button **[PROG]** (SP) to exit programming mode.

7.2 Reset Master Remote

1. Press push-button **[PROG]** (LP) to start programming mode (LED1 flashes).
2. Simultaneously press (VLP) **[Corridor]** and **[Staircase]** (LED2 flashes).
3. Press push-button **[PROG]** (LP) – (LED1 and LED2 light up orange for 3 seconds).

7.3 Reset User Remote

1. Simultaneously press (VLP) **[CH-1 ▲]** and **[Resume]** (LED flashes red).
2. Press push-button **[4]** (SP) – (LED lights up orange for 3 seconds).

8 Technical data

Mains connection	220 – 240 V AC 50-60 Hz
Push-button input	Floating NO contacts, Max. line length 50 m
Load (control) outputs DA1+/- /DA2+/-	In accordance with IEC 62386 ditto.
Control current	Max. 64 mA (per channel) Max. 96 mA (sum of both channels) Max. cable length 100 m (per channel)
Sensor system connection	DALIeco LS/PD LI = max. 4x DALIeco LS/PD LI HF = max. 1x Max. line length 25 m, with extension/shortening ensure contact allocation 1:1
Power consumption	0.2 W - 3.0 W (depending on ECG/number of sensors)
Ambient temperature	-20 °C to +50 °C (operation)
Type of protection	IP20
Protection rating	II, protective insulation
Conformity	CE



Important note:

If it is not possible to route the sensor lines and push-button lines of the sensors and push-buttons that are directly connected to the control unit separately from the mains and lamp lines, then we recommend incorporating the sensors and push-buttons via the DALI line.

DALleco Control - Instalación y funcionamiento

Índice

E

1	Indicaciones generales	31
1.1	Símbolos y abreviaturas en el presente manual	31
1.2	Uso previsto.....	31
2	Montaje e instalación	31
2.1	Asignación de conexiones de la unidad de control ▶ 3	31
2.2	Dimensiones y medidas de montaje ▶ 2	31
2.3	Esquema de conexiones de componentes eléctricos del sistema ▶ 4	31
2.4	Sensor e integración en red ▶ 5	31
2.5	Pulsador externo ▶ 4	31
2.6	Conexión de sensores y pulsadores adicionales a través de la línea DALI ▶ 5	31
2.6.1	Integración de pulsadores a través de acopladores de pulsadores...32	
2.6.2	Integración de sensores a través de acopladores de sensores	32
3	Función y componentes externos	33
3.1	Principio de funcionamiento básico	33
3.2	Control bicanal DALI 1 / DALI 2	33
3.3	Pulsador externo ▶ 4	33
3.4	Comportamiento tras una interrupción de la red	33
4	Funcionamiento	33
4.1	Mando a distancia Master Remote ▶ 7 (y ▶ manual específico)....33	
4.2	Mando a distancia User Remote ▶ 6 (y ▶ manual específico)	34
4.3	Conectar/desconectar el sistema.....	34
4.4	Regulación del sistema	34
5	Programación de sistema paso a paso mediante el Master Remote	34
5.1	Modo programación (modo PROG)	34
5.2	Modos de funcionamiento ▶ 8	35
5.3	Auto setup	35
5.4	Manual setup	35
5.5	Switch off delay (tiempo de retardo de desconexión)	35
5.6	Función de prueba	35
5.7	Stand-by-level	35
5.8	Stand-by-time.....	36

5.9	★ Funciones de luz diurna y  de presencia	36
5.10	Ajustar Offset	36
5.11	100 h de quemado inicial	36
5.12	Sensor select	37
5.13	PC modes	37
5.14	Macro Recorder	37
6	Funcionamiento del sistema mediante User Remote	37
6.1	Teclas de escenas [1] a [4] ▶ 7	37
6.2	Tecla [Holiday].....	37
6.3	Tecla [Resume]	37
6.4	Funcionamiento independiente de varios sistemas	38
7	Reinicio	38
7.1	Reinicio del sistema (mediante Master Remote).....	38
7.2	Reinicio de Master Remote	38
7.3	Reinicio de User Remote.....	38
8	Datos técnicos	38

1 Indicaciones generales

1.1 Símbolos y abreviaturas en el presente manual

- Punto en la lista, enumeración
- 1. Pasos de procedimiento numerados con orden predeterminado
- ▶ 2.2 Referencia a apartado (p. ej. 2.2) o a un manual específico (entonces sin cifras)
- ▶ 14 Referencia a imágenes (p. ej. a la imagen 13)

- SP** Abreviatura de "Short Press / pulsar brevemente la tecla" (<0,5 s)
- LP** Abreviatura de "Long Press / pulsar prolongadamente la tecla" (>0,5 s)
- VLP** "Very Long Press / pulsar la tecla durante mucho tiempo" (>10 s)
- DP** "Double Press / doble pulsación breve" (cada vez <0,5 s)



Símbolo "INFORMACIÓN / INDICACIÓN"

1.2 Uso previsto

Este producto ha sido desarrollado y concebido especialmente para el uso con sistemas de control de luz para luminarias. Cualquier otro uso diferente al descrito en el presente manual es un uso no previsto.

Símbolos empleados de los diagramas

	La luminaria está conectada: "ON"		La luminaria está desconectada: "OFF"
	Conexión automática de la iluminación por detección de presencia.		Conexión manual de la iluminación por pulsador externo.
	Tiempo de retardo 1: Tras haber abandonado la zona de detección de presencia.		Tiempo de retardo 2

2 Montaje e instalación

2.1 Asignación de conexiones de la unidad de control ▶ 3

- (1) Conexión a la red
- (2) Conexión a la red
- (3) Sin asignación
- (4) DALI 1(-)
- (5) DALI 1(+)
- (6) DALI 2(-)
- (7) DALI 2(+)
- (8) Sensor de conexión (4p4c)
- (9) Entrada de pulsador externo
- (10) Conexión Sync (sin función)
- (11) GND - potencial de referencia de pulsador externo

2.2 Dimensiones y medidas de montaje ▶ 2

2.3 Esquema de conexiones de componentes eléctricos del sistema ▶ 4

2.4 Sensor e integración en red ▶ 5

El sensor está diseñado para la integración de luminarias. Instalación y ajustes del sensor ▶ manual específico.

Conexión de máx. 4 sensores (3) a través de conector Y (4) y cable de sensor (2) en la conexión de sensor de la unidad de control (1).

Requisitos respecto a la posición de sensor y luminarias:

- Todo el lugar de trabajo (a supervisar) se encuentra en la zona de vigilancia del sensor.
- Evitar la radiación directa del sensor mediante fuentes de luz (fallos de medición).
- El sensor no debe instalarse en zonas con corrientes de aire (aire acondicionado/ventilación) o fuentes de calor (fotocopiadora/aerotermino) (simulan el movimiento de las personas).

2.5 Pulsador externo ▶ 4

Pulsador para el control/ajuste manual. Requisitos de conexión ▶ 8.

2.6 Conexión de sensores y pulsadores adicionales a través de la línea DALI ▶ 5

Los pulsadores y sensores adicionales pueden integrarse mediante acopladores con posibilidad de conexión directa con ambas líneas DALI. La función es independiente de si la conexión se produce a través del canal DALI 1 o 2. A cada canal DALI pueden conectarse hasta tres acopladores, además de los 16 DALI ECE.

E

2.6.1 Integración de pulsadores a través de acopladores de pulsadores

Los pulsadores pueden conectarse a la línea DALI mediante acopladores de pulsadores sin otra puesta en marcha. Cada acoplador de pulsadores conectado dispone de cuatro entradas (A-D).

Ajuste básico del acoplador de pulsadores

En el ajuste básico (=estado de entrega) todas las entradas/pulsadores tienen la misma función. La función se corresponde con el pulsador que esté conectado directamente a la entrada de pulsador de la unidad de control ▶ 3.3.

Función alternativa / asignación de pulsadores del acoplador de pulsadores

Función del pulsador en la entrada de acopladores A:

- **SP:** Conexión o desconexión DALI CH-1 (función Toggle)
- **LP:** Regulación ascendente o descendente DALI CH-1 (función Toggle)

Función del pulsador en la entrada de acopladores B:

- **SP:** Conexión o desconexión DALI CH-2 (función Toggle)
- **LP:** Regulación ascendente o descendente DALI CH-2 (función Toggle)

Función del pulsador en la entrada de acopladores C:

- **SP y LP:** Conexión o cambio del estado "Standby" al estado "ON"

Función del pulsador en la entrada de acopladores D:

- **SP y LP:** Desconexión o cambio del estado "ON" al estado "Standby"

Activación de la función alternativa / asignación de pulsadores del acoplador de pulsadores

1. Iniciar el modo de programación mediante **LP** en la tecla "Prog" (5) del mando a distancia
2. Activar Sensor Select mediante **LP** en la tecla (10) del mando a distancia
3. Accionar cualquier pulsador conectado al acoplador de pulsadores
4. La iluminación regula hasta un 10 % de luminosidad mostrando así el comienzo del proceso de configuración
5. Tras aprox. 1 minuto (dependiendo del número de acopladores) concluye el proceso y la iluminación parpadea dos veces para confirmar

Restablecer el ajuste básico del acoplador de pulsadores ▶ 6

1. Iniciar el modo de programación mediante **LP** en la tecla "Prog" (5) del mando a distancia
2. Activar Sensor Select mediante la tecla (10) del mando a distancia
3. Accionar cualquier pulsador conectado al acoplador de pulsadores durante más de 10 s
4. La iluminación regula hasta un 10 % de luminosidad mostrando así el comienzo del proceso de restablecimiento

Una vez concluido el proceso de restablecimiento, la iluminación cambia brevemente al 100 %, a continuación se ajusta de nuevo el valor de partida.

2.6.2 Integración de sensores a través de acopladores de sensores

Los sensores pueden ser conectados a la línea DALI mediante acopladores de sensores sin otra puesta en marcha y permiten la ampliación de la zona de detección de presencia.

Los valores de luz de estos sensores no son evaluados.



Indicación importante:

Para la configuración del control mediante mando a distancia por infrarrojos debe estar instalado al menos un sensor en la interfaz de sensores de la unidad de control.



Indicación importante:

La regulación de luz diurna emplea únicamente los valores de luz de los sensores conectados a la interfaz de sensores.

3 Función y componentes externos

3.1 Principio de funcionamiento básico

La unidad de control modifica/conmuta la iluminación de lugares de trabajo, pasillos y otras salas de uso común en función de la luz diurna aprovechable y la presencia/el movimiento de las personas. Esto queda registrado por los sensores. De este modo, aumenta el confort de trabajo y se ahorra energía. Existen modos de función para diversas aplicaciones/escenarios ▶ 8. Estos pueden ser adaptados individualmente ▶ 5.

3.2 Control bicanal DALI 1 / DALI 2

Las luminarias pueden funcionar tras la instalación eléctrica DALI 1 (CH-1) y DALI 2 (CH-2) con valores de luz idénticos o con OFFSET para CH-2 ▶ 5.10.

3.3 Pulsador externo ▶ 4

La activación de un pulsador externo tiene prioridad frente a las funciones automáticas.

3.4 Comportamiento tras una interrupción de la red

Dependiendo del modo de funcionamiento previamente ajustado, el sistema está en un estado preajustado cuando la tensión de red esté disponible de nuevo:

Modo de funcionamiento	Estado
Single Office	OFF
Open Plan Office	OFF
Corridor	STANDBY
Meeting-/Classroom	LAST STATE
Sanitary Room	STANDBY
Staircase	STANDBY
No se ha seleccionado modo de funcionamiento	LAST STATE

4 Funcionamiento

Descripción de todas las teclas/LED del Master Remote y sus funciones que no requieren un uso de la tecla **[PROG]**, así como la descripción de todas las teclas/LED del User Remote y sus funciones básicas.

4.1 Mando a distancia Master Remote ▶ 7 (y ▶ manual específico)

Teclas / LED / Conexiones

- (1) **[ON/OFF]** iluminación conectada/desconectada
- (2) Señalización LED 1 (verde/rojo/naranja)
- (3) **[test]** modo de prueba para el ajuste de la zona de detección (1 segundo de tiempo de retardo de desconexión)
- (4) **[Funktionsmodi]** selección
- (5) **[PROG]** modo de programación conectado/desconectado
- (6) **[100 h Burn-in]** conectado/desconectado
- (7) **[Auto setup]** activación de memorización automática de valor teórico
- (8) **[CH-1]** ajustar la luminosidad del canal 1 (manualmente/directamente)
- (9) **[Stand-by-time]** selección especificaciones de tiempo STANDBY
- (10) **[Sensor select]** selección sensor
- (11) Señalización LED 2 (verde/rojo/naranja)
- (12) **[Switch off delay]** selección de especificaciones del tiempo de retardo de desconexión
- (13) **[Macro Recorder]** grabar/memorizar/enviar secuencia de teclas
- (14) **[Offset]** ajuste OFFSET conectado/desconectado
- (15) **[PC modes]** sin función
- (16) **[CH-2]** ajustar la luminosidad del canal 2 (manualmente/directamente)
- (17) **[Manual setup]** ajuste manual de valor de luz
- (18) **[Stand-by-level]** selección especificaciones de STANDBY
- (19) **[]** selección funciones de luz diurna/presencia conectada/semiautomática/desconectada
- (20) Conexión USB Mini

Señalización LED

- LED 1 - parpadea rápidamente durante la transmisión de señal (IR) (verde)
- LED 1 - parpadea en modo "PROG" (rojo)
- LED 1 - se ilumina durante la transmisión USB (naranja)
- LED 2 - parpadea en modo "Sensor Select" (verde)
- LED 1/LED 2 - se iluminan durante "Reset" Master Remote (naranja)

E

4.2 Mando a distancia User Remote 7 (y ► manual específico)

Teclas / LED

- (21) **[ON/OFF]** todas las luminarias conectadas/desconectadas
 (22) Señalización LED (verde/rojo/naranja)
 (23) **[1]** tecla escenas 1
 (24) **[3]** tecla escenas 3
 (25) **[Holiday]** activación modo Holiday
 (26) **[CH-1]** ajustar la luminosidad del canal 1 (manualmente/directamente)
 (27) **[2]** tecla escenas 2
 (28) **[4]** tecla escenas 4
 (29) **[Resume]** Reanudación de la función automática de luz diurna
 (30) **[CH-2]** ajustar la luminosidad del canal 2 (manualmente/directamente)

Señalización LED (22)

- verde - parpadea rápidamente durante la transmisión de señal (IR)
- rojo - parpadea en modo "Memorizar"
- naranja - se ilumina durante "Reset" User Remote

4.3 Conectar/desconectar el sistema



Pulsador externo:

1. Presionar el pulsador externo (SP) para conectar o desconectar la iluminación.



Master Remote y User Remote:

1. Pulsa la tecla **[ON/OFF]** (SP) para conectar o desconectar CH-1 (DALI 1) y CH-2 (DALI 2).

4.4 Regulación del sistema



Pulsador externo:

1. Presionar el pulsador externo (LP) para aumentar o reducir respectivamente la luminosidad de ambos canales.



Master Remote y User Remote:

1. Mantener pulsadas las teclas **[CH-1]** o **[CH-2]** arriba/abajo para aumentar/reducir la luminosidad de los canales DALI 1 y DALI 2 de manera independiente.

5 Programación de sistema paso a paso mediante el Master Remote

La programación o configuración se lleva a cabo mediante el Master Remote o directamente en el sensor.

En caso de pulsar la tecla del Master Remote, orientarlo siempre hacia el sensor correspondiente.

Paso 1	Activación del modo PROG	Modo de programación ► 5.1
Paso 2	Selección del modo de funcionamiento	Modos de funcionamiento ► 5.2
Paso 3	Especificación de valor teórico para la regulación de la luz	Auto setup ► 5.3 o Manual setup ► 5.4
Paso 4	Adaptación individual del modo de funcionamiento seleccionado	Tiempo de retardo de desconexión ► 5.5 Función de prueba ► 5.6 Stand-by-level ► 5.7 Stand-by-time ► 5.8 Funciones de luz diurna y de presencia ► 5.9
Paso 5	Adaptación del valor lumínico para canal 2 (CH-2)	Offset ► 5.10
Paso 6	Funciones especiales	100 h Burn-in ► 5.11 Sensor select ► 5.12 PC modes ► 5.13 Macro Recorder ► 5.14

5.1 Modo programación (modo PROG)



1. Pulsar la tecla **[PROG]** (LP) para activar el modo de programación (LED 1 parpadea). CH-1 / CH-2 se regulan hasta el último valor teórico memorizado (predeterminado = 80 %).
2. Programación paso a paso, explicado en ► 5.1 hasta ► 5.14 (posibilidad de varias funciones/ajustes consecutivos).
3. Pulsar la tecla **[PROG]** (SP) para memorizar ajustes y abandonar el modo de programación.

Si el modo PROG no se abandona deliberadamente, los ajustes serán efectivos una vez transcurridos 60 segundos. El modo PROG concluye automáticamente transcurridos 60 segundos sin activación de tecla.

5.2 Modos de funcionamiento ▶ 8

Comportamiento de conmutación de los modos de función preconfigurados: Diagramas ▶ 9 hasta ▶ 14 .



- Single Office ▶ 9
- Open-plan Office ▶ 10
- Corridor ▶ 11
- Meeting / Classroom ▶ 12
- Sanitary Room ▶ 13
- Staircase ▶ 14

5.3 Auto setup

Ajusta el valor teórico de la regulación de luz a 80 % de la máxima potencia de iluminación.

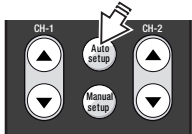

1. Pulsar la tecla [Auto setup] (SP) para iniciar el calibrado. Tras el calibrado de 3 minutos, la iluminación parpadea y se inicia la regulación automática de luz.
Indicación: Durante el "AutoSet Up" no hay posibilidad de ajustes. El modo "Prog" concluye automáticamente una vez ejecutado el "AutoSet Up".

5.4 Manual setup

Memoriza el valor teórico con cualquier valor ajustable.

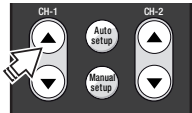

1. Pulsar el interruptor basculante [CH-1] hacia arriba/abajo con el fin de ajustar el valor teórico para la regulación.

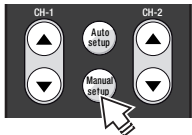

2. Pulsar la tecla [Manual setup] (SP) para memorizar la potencia de iluminación actual como valor teórico (las lámparas parpadean).

i Indicación:

Si la regulación de luz está desactivada, la unidad de control aumenta en un paso el valor de luz memorizado cada 2.000 h de quemado, compensando así automáticamente el envejecimiento del elemento de iluminación. En caso de cambio del elemento de iluminación, debe memorizarse de nuevo el valor teórico para iniciar nuevamente el proceso.

5.5 Switch off delay (tiempo de retardo de desconexión)

El temporizador se ajusta tras la última detección de presencia hasta abandonar el estado "ON" (cambio a "STANDBY" u "OFF"). En los modos de funcionamiento "Corridor", "Staircase" y "Sanitary", el temporizador se inicia al conectar la iluminación, incluso con la detección de presencia desactivada. De este modo, se hace posible un control en función del tiempo, incluso con funcionamiento puramente manual.

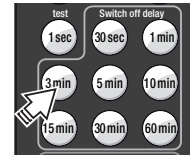

1. Pulsar la tecla [Switch off delay 3 min] (SP), para ajustar un tiempo de retardo de desconexión de 3 minutos para CH-1 y CH-2.

5.6 Función de prueba

Con la función de prueba puede comprobarse la zona de detección del sensor

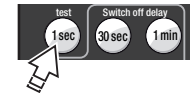

1. Pulsar la tecla [test] (SP) para conectar la función de prueba.
2. Pulsar la tecla [PROG] (SP) para iniciar la prueba.
3. Entrar en la zona de detección:
 - en caso de detección, se obtiene 100 % ON,
 - sin detección tras 1 s vuelve a 1 % ON.
4. En caso necesario, modificar la zona de detección ajustando las molduras del sensor y repetir los pasos 3. y 4. las veces que sea necesario.
5. Tras una prueba satisfactoria, esperar 60 segundos o pulsar la tecla [ON/OFF] o [CH-1/CH-2] previamente (SP) para desconectar la función de test (regreso al funcionamiento normal).

5.7 Stand-by-level

Ajustar la luminosidad (%) en STANDBY o desconectar la función STANDBY.

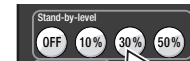

1. Por ejemplo, pulsar la tecla [Stand-by-level 30%] (SP o LP) para ajustar STANDBY para CH-1 (CH-2 sigue dado el caso con OFFSET ▶ 5.10).

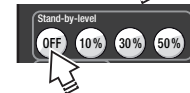

2. Pulsar la tecla [Stand-by-level OFF] (SP o LP) para desconectar la función STANDBY.

E

5.8 Stand-by-time

Ajustar la duración del STANDBY o conectar la función STANDBY de forma permanente.



- Pulsar una de las teclas [Stand-by-time] (SP o LP) con el fin de ajustar el tiempo de STANDBY para CH-1 y CH-2. Si se selecciona [Stand-by-time ∞], la iluminación no se desconecta nunca.

5.9 Funciones de luz diurna y de presencia

Las funciones de luz diurna y de presencia pueden ser seleccionadas:

- para todos los sensores conectados a la vez (modo PROG ► 5.1)
- para cada uno de los sensores (Sensor select ► 5.12).

Funciones de luz diurna

	Tecla [ON]	• Regulación de luz diurna completamente automática activada
	Tecla [Semi Auto]	• Desconexión automática en caso de exceso de luz diurna • Conexión manual
	Tecla [OFF]	• Regulación de luz diurna desconectada

Funciones de presencia

	Tecla [ON]	• Detección de presencia activa
	Tecla [Semi Auto]	• Cambio automático a "STANDBY" o a "OFF" una vez transcurrido el tiempo de retardo de desconexión • Conexión manual
	Tecla [OFF]	• Detección de presencia desconectada

5.10 Ajustar Offset

Ajustar el OFFSET (= distancia de CH-2 a CH-1) de un modo de funcionamiento determinado.



1. Pulsar la tecla **[Offset]** (SP).

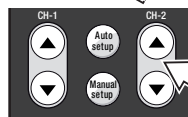

2. Offset se ajusta mediante tecla basculante **[CH-2]**:
 - LP = ajuste grueso
 - SP = ajuste fino

El Offset de CH-2 puede comprender:

- mín. = valor de CH-1
- máx. = 100 % luminosidad

3. Pulsar la tecla **[Offset]** (SP) para memorizar el ajuste.

5.11 100 h de quemado inicial

En caso de utilización de lámparas de material fluorescente, quedan garantizados los pasos de trabajo estables y la máxima vida útil solo después de una fase de quemado inicial (de 100 h a 100 %). Durante el quemado inicial, todas las funciones automáticas se encuentran desconectadas y todas las lámparas del sistema se iluminan con un 100 %.

Los LED de todos los sensores conectados se iluminan permanentemente en rojo.

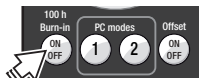

1. En caso de puesta en marcha o antes de un uso regular del sistema, pulsar la tecla **[100 h Burn-in ON/OFF]** (SP) para iniciar el proceso.
2. Pulsar nuevamente la tecla **[100 h Burn-in ON/OFF]** para concluir el proceso (SP).

Con cada activación de función, se reinicia el plazo temporal de 100 h.

5.12 Sensor select



1. Pulsar la tecla **[Sensor select]** (LP) para seleccionar un sensor (el LED del sensor seleccionado parpadea).
Indicación LED en el sensor:
 - Naranja = sensor seleccionado
 - Rojo = función de presencia activa
 - Verde = función de luz diurna activa
2. Efectuar los ajustes del sensor ► 5.9.
3. Si se dispone de varios sensores en el sistema, pulsar de nuevo la tecla **[Sensor select]** (SP) para seleccionar el siguiente sensor.
4. Pulsar la tecla **[Sensor select]** (LP) para memorizar los ajustes del sensor o pulsar la tecla **[PROG]** (SP).

5.13 PC modes



Sin función.

5.14 Macro Recorder



Sin función.

6 Funcionamiento del sistema mediante User Remote

En caso de pulsar la tecla del User Remote, orientarlo siempre hacia el sensor correspondiente.

6.1 Teclas de escenas [1] a [4] ► 7

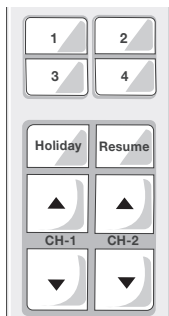

- **Acceder a una escena:** Selección de la escena de luz memorizada pulsando una tecla (SP).
- **Memorizar escena:** una potencia de iluminación modificada manualmente a través de **[CH-1]** y/o **[CH-2]** puede memorizarse pulsando una tecla (LP) en la tecla de escena deseada (el sistema parpadea como confirmación).
- **Bloquear la memorización de escenas o liberarla de nuevo:**
 1. Pulsar simultáneamente las teclas **[Holiday]+[CH-2 ▲]** (VLP) (el LED rojo parpadea).
 2. - Pulsar la tecla **[1]** (SP) para bloquear la memorización de escenas (el LED se ilumina en rojo durante tres segundos)
 - Pulsar la tecla **[2]** (SP) para liberar la memorización de escenas (el LED se ilumina en verde durante tres segundos).

E

6.2 Tecla [Holiday]

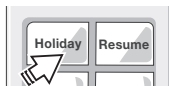

Desactivación temporal de la detección de presencia pulsando una tecla (SP), el LED del sensor permanece en rojo.
Posibilidad de reactivación mediante teclas **[ON/OFF]**, teclas de escena **[1]** a **[4]** y **[CH-1]/[CH-2]**.

6.3 Tecla [Resume]

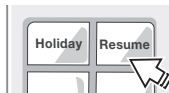

Reanudación de la función automática de control de luz pulsando una tecla (SP). En modos de funcionamiento sin regulación de luz, esta tecla no tiene función.

6.4 Funcionamiento independiente de varios sistemas

Programación del User Remote para un receptor determinado seleccionado, con el fin de permitir un funcionamiento independiente de varios sistemas (máximo 15) en el mismo espacio.



1. Pulsar simultáneamente las teclas **[CH-1 ▼]** + **[CH-2 ▼]** (VLP) para iniciar la programación individual (el LED rojo parpadea).
2. Activar el bloque de números (ajuste de fábrica = 16):
 - Bloque de números 1-4: Pulsar la tecla **[1]** (SP).
 - Bloque de números 5-8: Pulsar la tecla **[2]** (SP).
 - Bloque de números 9-12: Pulsar la tecla **[3]** (SP).
 - Bloque de números 13-16: Pulsar la tecla **[4]** (SP).
3. Programar número de sistema:
 - Pulsar la tecla **[1]**, **[2]**, **[3]** o **[4]** (SP) para el número de sistema a programar (ajuste de fábrica = 16) (el LED verde parpadea dos veces y el sistema parpadea como confirmación).

--> Ejemplo: Programar el número de sistema 10:

1. Pulsar las teclas **[CH-1 ▼]** + **[CH-2 ▼]** simultáneamente (VLP) (el LED rojo parpadea).
2. Pulsar la tecla **[3]** (SP) para activar el bloque de números 9-12.
3. Pulsar la tecla **[2]** (SP) para programar el número de sistema 10 (el LED verde parpadea dos veces y el sistema parpadea como confirmación).

7 Reinicio

7.1 Reinicio del sistema (mediante Master Remote)

1. Pulsar la tecla **[PROG]** (LP) para iniciar el modo de programación (el LED1 parpadea).
2. Pulsar **[Single Office]** (SP) para ajustar el modo de funcionamiento predeterminado (el LED1 parpadea con rapidez).
3. Pulsar la tecla **[PROG]** (SP) para salir del modo de programación.

7.2 Reinicio de Master Remote

1. Pulsar la tecla **[PROG]** (LP) para iniciar el modo de programación (el LED1 parpadea).
2. Pulsar simultáneamente (VLP) **[Corridor]** y **[Staircase]** (el LED2 parpadea).
3. Pulsar la tecla **[PROG]** (LP) – (LED1 y LED2 se iluminan en color naranja durante 3 segundos).

7.3 Reinicio de User Remote

1. Pulsar simultáneamente (VLP) **[CH-1 ▲]** y **[Resume]** (el LED rojo parpadea).
2. Pulsar la tecla **[4]** (SP) – (el LED se ilumina en color naranja durante 3 segundos).

8 Datos técnicos

Conexión a red	220 – 240 V CA 50-60 Hz
Entrada de pulsador	Contacto de cierre flotante, máx. longitud de línea 50 m
Salidas (de control) de carga DA1+/- / DA2+/-	según IEC 62386 ídem.
Corriente de control	máx. 64 mA (por canal) máx. 96 mA (suma de ambos canales) máx. longitud de cable 100 m (por canal)
Conexión de los sensores	DALIeco LS/PD LI = máx. 4x DALIeco LS/PD LI HF = máx. 1x máx. longitud de línea 25 m, en caso de prolongación/reducción asegurar la asignación de contactos 1:1
Consumo de potencia	0,2 W - 3,0 W (en función del número de ECE/sensores)
Temperatura ambiente	de -20 °C a +50 °C (funcionamiento)
Grado de protección	IP20
Clase de protección	II, aislamiento de protección
Conformidad	CE



i Indicación importante:

Si no es posible tender las líneas de los sensores y las líneas de los pulsadores de los sensores y pulsadores conectados directamente a la unidad de control separadas de las líneas de la red y las lámparas, recomendamos integrar los sensores y pulsadores a través de la línea DALI.

DALleco Control - Installation et utilisation

Sommaire

1	Remarques générales	41
1.1	Symboles et abréviations de cette notice.....	41
1.2	Utilisation conforme.....	41
2	Montage et installation	41
2.1	Occupation des branchements de l'unité de commande ▶ 3	41
2.2	Dimensions et mesures de montage ▶ 2	41
2.3	Schéma de raccordement des composants système électriques ▶ 4	41
2.4	Cellule et mise en réseau ▶ 5	41
2.5	Bouton-poussoir externe ▶ 4	41
2.6	Branchement de cellule et boutons-poussoirs supplémentaires via la ligne DALI ▶ 5	41
2.6.1	Intégration de boutons-poussoirs via le coupleur de boutons- poussoirs	42
2.6.2	Intégration de cellules via le coupleur	42
3	Fonction et composants externes	43
3.1	Fonctionnement de base.....	43
3.2	DALI 1 / DALI 2 commande à deux canaux.....	43
3.3	Bouton-poussoir externe ▶ 4	43
3.4	Comportement après une coupure de secteur	43
4	Utilisation	43
4.1	Télécommande Master Remote ▶ 7 (et ▶ notice séparée)	43
4.2	Télécommande Master User ▶ 6 (et ▶ notice séparée)	44
4.3	Allumer/éteindre le système	44
4.4	Gradateur.....	44
5	Système de programmation étape par étape via Master Remote	44
5.1	Mode de programmation (mode PROG)	44
5.2	Modes de fonctionnement ▶ 8	45
5.3	Auto setup	45
5.4	Manual setup	45
5.5	Switch off delay (temporisation)	45
5.6	Fonction de test.....	45
5.7	Stand-by-level	45
5.8	Stand-by-time.....	46

5.9	 Fonctions lumière du jour et  présence	46
5.10	Régler l'offset	46
5.11	100 h Burn-in.....	46
5.12	Sensor select	47
5.13	PC modes.....	47
5.14	Macro Recorder	47
6	Utilisation du système avec User Remote	47
6.1	Touches scène [1] à [4] ▶ 7	47
6.2	Bouton [Holiday].....	47
6.3	Bouton [Resume]	47
6.4	Utilisation indépendante de plusieurs systèmes.....	48
7	Réinitialisation	48
7.1	System Reset (avec Master Remote).....	48
7.2	Reset Master Remote.....	48
7.3	Reset User Remote	48
8	Caractéristiques techniques	48

1 Remarques générales

1.1 Symboles et abréviations de cette notice







- Point de liste, énumération
 - 1. Étapes de procédure numérotées avec ordre prédéterminé
 - ▶ 2.2 Renvoi à la section (p. ex. 2.2) ou à une notice séparée (alors sans chiffre)
 - ▶ 14 Renvoi à une image (p. ex. image 13)
- SP** Abréviation pour «Short Press / Appuyer brièvement sur la touche » (< 0,5 s)
- LP** Abréviation pour «Long Press / Appuyer longtemps sur la touche » (>0,5 s)
- VLP** « Very Long Press / Appuyer très longtemps sur la touche » (>10 s)
- DP** « Double Press / Appuyer brièvement deux fois sur la touche » (respectivement < 0,5 s)

 Symbole « INFORMATION / INFORMATION »

1.2 Utilisation conforme

Ce produit est conçu et prévu spécialement pour une utilisation avec des systèmes de gestion de l'éclairage pour les luminaires. Toute autre utilisation que celle décrite dans ce mode d'emploi sera considérée comme étant non conforme.

Symbolique utilisée dans les diagrammes

	Le luminaire est allumé : « ON »		Le luminaire est éteint : « OFF »
	Allumage automatique de l'éclairage par la détection de présence.		Allumage manuel de l'éclairage par bouton-poussoir externe.
 min.	Temporisation 1 : Après avoir quitté la zone de détection de présence.	 min.	Temporisation 2

2 Montage et installation

2.1 Occupation des branchements de l'unité de commande ▶ 3

- (1) Branchement secteur
- (2) Branchement secteur
- (3) non occupé
- (4) DALI 1(-)
- (5) DALI 1(+)
- (6) DALI 2(-)
- (7) DALI 2(+)
- (8) Branchement cellule (4p4c)
- (9) Entrée bouton-poussoir externe
- (10) Branchement Sync (sans fonction)
- (11) GND Potentiel de référence de bouton-poussoir externe

2.2 Dimensions et mesures de montage ▶ 2

2.3 Schéma de raccordement des composants système électriques ▶ 4

2.4 Cellule et mise en réseau ▶ 5

La cellule est prévue pour l'intégration de luminaires. Installation et réglage de la cellule ▶ notice séparée.

Branchement de max. 4 cellules (3) via le connecteur Y (4) et câble de cellule (2) sur le branchement de cellules de l'unité de commande (1).

Exigences concernant la position de la cellule et des luminaires :

- Tout le poste de travail (à surveiller) se trouve dans la zone de surveillance de la cellule.
- Le rayonnement direct de la cellule par des sources lumineuses doit être évité (mesures erronées).
- La cellule ne doit pas être installée dans des endroits exposés à des courants d'air (climatisation/ventilation) ou à des sources de chaleur (photocopieuse/chauffage) qui entraînent des simulations de mouvements de personnes.

2.5 Bouton-poussoir externe ▶ 4

Bouton-poussoir de commande/réglage manuel. Conditions de branchement ▶ 8.

2.6 Branchement de cellule et boutons-poussoirs supplémentaires via la ligne DALI ▶ 5

Des boutons-poussoirs et cellules supplémentaires peuvent être directement intégrés aux deux lignes DALI via des coupleurs connectables. Le fonctionnement est indépendant du branchement via le canal DALI 1 ou 2. Sur chaque canal DALI, il est possible de raccorder outre les 16 ballasts électroniques DALI, jusqu'à trois coupleurs.

F
B

2.6.1 Intégration de boutons-poussoirs via le coupleur de boutons-poussoirs

Des boutons-poussoirs peuvent être raccordés via le coupleur de boutons-poussoirs sans autre mise en service de la ligne DALI. Chaque coupleur de boutons-poussoirs raccordé possède quatre entrées (A-D).

Réglage de base du coupleur de boutons-poussoirs

Dans le réglage de base (= état de livraison), toutes les entrées/boutons-poussoirs ont la même fonction.

La fonction correspond au bouton-poussoir qui est raccordé directement à l'entrée de bouton-poussoir de l'appareil de commande ► 3.3.

Fonction alternative/occupation des boutons du coupleur

Fonction du bouton-poussoir sur l'entrée du coupleur A :

- **SP**: Allumer ou éteindre DALI CH-1 (fonction Toggle)
- **LP**: Augmenter ou diminuer la gradation du DALI CH-1 (fonction Toggle)

Fonction du bouton-poussoir sur l'entrée du coupleur B :

- **SP**: Allumer ou éteindre DALI CH-2 (fonction Toggle)
- **LP**: Augmenter ou diminuer la gradation du DALI CH-2 (fonction Toggle)

Fonction du bouton-poussoir sur l'entrée du coupleur C :

- **SP et LP**: Allumer ou commuter de l'état stand-by à l'état « ON »

Fonction du bouton-poussoir sur l'entrée du coupleur D :

- **SP et LP** : Éteindre ou commuter de l'état « ON » à l'état « stand-by »

Activer la fonction alternative/occupation des boutons du coupleur

1. Démarrer le mode de programmation via **LP** avec la touche « Prog » (5) de la télécommande
2. Activer Sensor Select via **LP** avec la touche « Prog » (10) de la télécommande
3. Appuyer sur un bouton-poussoir quelconque raccordé au coupleur
4. L'éclairage réduit la clarté à 10 %, ce qui indique le début du processus de configuration.
5. Après environ 1 minute (selon le nombre de coupleurs), le processus est terminé et l'éclairage clignote deux fois pour confirmer

Réinitialiser le coupleur à la configuration par défaut ► 6

1. Démarrer le mode de programmation via **LP** avec la touche « Prog » (5) de la télécommande
2. Activer Sensor Select avec la touche (10) de la télécommande
3. Appuyer pendant plus de 10 s sur un bouton quelconque raccordé au coupleur
4. L'éclairage réduit la clarté à 10 %, ce qui indique le début du processus de configuration.

Après ce processus de réinitialisation, l'éclairage commute brièvement sur 100 % et est réglé de nouveau à sa valeur initiale.

2.6.2 Intégration de cellules via le coupleur

Il est possible de raccorder des cellules via le coupleur sans autre mise en service de la ligne DALI, ce qui permet d'élargir la zone de détection de présence.

L'intensité lumineuse de ces cellules n'est pas analysée.



Remarque importante :

Pour configurer la commande à l'aide d'une télécommande infrarouge, il faut qu'une cellule au moins soit raccordée à l'interface cellules de l'appareil de commande.



Remarque importante :

Le réglage de la lumière du jour utilise uniquement l'intensité lumineuse des cellules raccordées à l'interface cellules.

3 Fonction et composants externes

3.1 Fonctionnement de base

L'unité de commande modifie/commute l'éclairage sur les postes de travail, dans les couloirs et autres espaces communs en fonction de la lumière du jour et de la présence/du mouvement de personnes. Ceux-ci sont enregistrés par des cellules. Ainsi, le confort de travail est optimisé et cela permet d'économiser de l'énergie. Il existe des modes de fonctionnement pour différentes applications/scénarios .

Ceux-ci peuvent être adaptés individuellement .

3.2 DALI 1 / DALI 2 commande à deux canaux

Les luminaires peuvent fonctionner après l'installation électrique sur DALI 1 (CH-1) et DALI 2 (CH-2) avec des intensités lumineuses identiques ou avec OFFSET pour CH-2 .

3.3 Bouton-poussoir externe

L'actionnement d'un bouton-poussoir externe a priorité sur les fonctions automatiques.

3.4 Comportement après une coupure de secteur

Selon le mode de fonctionnement réglé au préalable, le système se trouve dans l'état pré-réglé, lorsque la tension secteur est rétablie :



Mode de fonctionnement	État
Single Office	OFF
Open Plan Office	OFF
Corridor	STANDBY
Meeting-/Classroom	LAST STATE
Sanitary Room	STANDBY
Staircase	STANDBY
Aucun mode de fonctionnement sélectionné	LAST STATE

4 Utilisation

Description de toutes les touches/LED du Master Remote et de leurs fonctions qui ne requièrent pas l'utilisation de la touche **[PROG]** ainsi que la description de toutes les touches /LED du User Remote et de leurs fonctions de base.

4.1 Télécommande Master Remote (et notice séparée)

Touches / LED / branchements

- (1) **[ON/OFF]** Éclairage on/off
- (2) Signalisation LED 1 (vert/rouge/orange)
- (3) **[test]** Mode test pour régler la zone de détection (1 seconde de temporisation)
- (4) **[Funktionsmodi]** Sélection
- (5) **[PROG]** Mode de programmation on/off
- (6) **[100 h Burn-in]** on/off
- (7) **[Auto setup]** Activation de l'enregistrement de la valeur du seuil
- (8) **[CH-1]** Régler la clarté du canal 1 (manuellement/directement)
- (9) **[Stand-by-time]** Sélection paramètres de la durée STANDBY
- (10) **[Sensor select]** Sélection de la cellule
- (11) Signalisation LED 2 (vert/rouge/orange)
- (12) **[Switch off delay]** Sélection réglage de la durée de temporisation
- (13) **[Macro Recorder]** Séquence de touches enregistrer/sauvegarder/envoyer
- (14) **[Offset]** Réglage OFFSET on/off
- (15) **[PC modes]** Sans fonction
- (16) **[CH-2]** Régler la clarté du canal 2 (manuellement/directement)
- (17) **[Manual setup]** Réglage manuel des valeurs de luminosité
- (18) **[Stand-by-level]** Sélection réglage STANDBY
- (19)   Sélection fonctions lumière du jour/présence on/automatique/off
- (20) Branchement USB Mini

Signalisation des LED

- LED 1 - clignote rapidement lors de la transmission de signaux (IR) (vert)
- LED 1 - clignote dans le mode « Prog » (rouge)
- LED 1 - clignote pendant la transmission USB (orange)
- LED 2 - clignote en mode « Sensor Select » (vert)
- LED 1/LED 2 - clignotent pendant « Reset » Master Remote (orange)



4.2 Télécommande Master User 7 (et ► notice séparée)

Touches/LED

- (21) **[ON/OFF]** Tous les éclairages on/off
 (22) Signalisation LED (vert/rouge/orange)
 (23) **[1]** Touche scène 1
 (24) **[3]** Touche scène 3
 (25) **[Holiday]** Activer le mode Holiday
 (26) **[CH-1]** Régler la clarté du canal 1 (manuellement/directement)
 (27) **[2]** Touche scène 2
 (28) **[4]** Touche scène 4
 (29) **[Resume]** Reprise de la fonction automatique lumière du jour
 (30) **[CH-2]** Régler la clarté du canal 2 (manuellement/directement)

F
B

Signalisation LED (22)

- vert - clignote rapidement lors de la transmission de signaux (IR)
- rouge - clignote pendant le mode « Enregistrer »
- orange - clignote pendant « Reset » User Remote

4.3 Allumer/éteindre le système



Bouton externe :

1. Appuyer sur le bouton-poussoir externe (SP) pour allumer ou éteindre l'éclairage.



Master Remote et User Remote :

1. Appuyer sur **[ON/OFF]** (SP), pour allumer ou éteindre CH-1 (DALI 1) et CH-2 (DALI 2).

4.4 Gradateur



Bouton externe :

1. Appuyer sur le bouton externe (LP), pour augmenter ou diminuer la clarté des deux canaux.

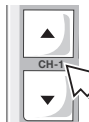

Master Remote et User Remote :

1. Maintenir enfoncé **[CH-1]** ou **[CH-2]** vers le haut/bas pour augmenter/diminuer la clarté des canaux DALI 1 et DALI 2 indépendamment l'un de l'autre.

5 Système de programmation étape par étape via Master Remote

La programmation du système est effectuée via Master Remote ou directement sur la cellule. En appuyant sur la touche Master Remote, toujours pointer vers la cellule correspondante.

Étape 1	Activation du mode PROG	Mode de programmation ► 5.1
Étape 2	Sélection du mode de fonctionnement	Modes de fonctionnement ► 5.2
Étape 3	Paramétrage de la valeur du seuil pour le réglage de la lumière	Auto setup ► 5.3 ou Manual setup ► 5.4
Étape 4	Adaptation individuelle du mode de fonctionnement sélectionné	Temporisation ► 5.5 Fonction test ► 5.6 Stand-by-level ► 5.7 Stand-by-time ► 5.8 Fonctions lumière du jour et présence ► 5.9
Étape 5	Adaptation de l'intensité lumineuse pour le canal 2 (CH-2)	Offset ► 5.10
Étape 6	Fonctions spéciales	100 h Burn-in ► 5.11 Sensor select ► 5.12 Modes PC ► 5.13 Macro Recorder ► 5.14

5.1 Mode de programmation (mode PROG)



1. Appuyer sur **[PROG]** (LP), pour activer le mode de programmation (la LED 1 clignote). CH-1 / CH-2 sont réglés sur la dernière valeur du seuil enregistrée (Default = 80 %).
2. Programmation étape par étape expliquée sous ► 5.1 à ► 5.14 (plusieurs fonctions/réglages possibles les uns après les autres).
3. Appuyer sur **[PROG]** (SP), pour enregistrer les réglages et quitter le mode de programmation.

Si le mode PROG n'est pas quitté volontairement, les réglages prennent effet après 60 secondes. Le mode PROG s'arrête automatiquement après 60 secondes, si aucun bouton n'est actionné.

5.2 Modes de fonctionnement ▶ 8

Comportement de commutation des modes de fonctionnement préconfigurés : Diagrammes

▶ 9 jusqu'à ▶ 14.



- Single Office ▶ 9
- Open-plan Office ▶ 10
- Corridor ▶ 11
- Meeting - / Classroom ▶ 12
- Sanitary Room ▶ 13
- Staircase ▶ 14

5.3 Auto setup

Règle la valeur du seuil du réglage de la lumière sur 80 % de la puissance d'éclairage maximale.

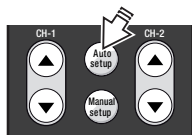

1. Appuyer sur [Auto setup] (SP), pour démarrer le calibrage. Après un calibrage de 3 minutes, l'éclairage clignote et le réglage de la lumière automatique démarre. Remarque : Pendant « AutoSet Up » aucun réglage possible. Le mode « Prog » s'arrête automatiquement une fois « l'Auto-set up » exécuté.

5.4 Manual setup

Enregistre la valeur du seuil selon une valeur réglable quelconque.

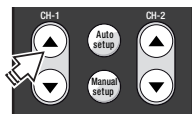

1. Appuyer sur le bouton à bascule **[CH-1]** vers le haut/bas, pour régler la valeur du seuil pour le réglage.

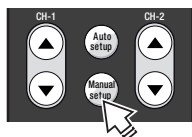

2. Appuyer sur **[Manual setup]** (SP), pour enregistrer la puissance d'éclairage actuelle en tant que valeur du seuil (les lampes clignotent).

i Remarque :

Si le réglage de la lumière est désactivé, l'appareil de commande augmente d'un pas toutes les 2.000 h d'éclairage l'intensité lumineuse enregistrée et compense ainsi automatiquement le vieillissement du luminaire. Lorsque le luminaire est remplacé, il faut enregistrer de nouveau la valeur du seuil, pour redémarrer la procédure.

5.5 Switch off delay (temporisation)

Minuterie active jusqu'à la fin de l'état « ON » (passage à « stand-by » ou « OFF ») après la dernière présence. Avec les modes de fonctionnement « Corridor », « Staircase » et « Sanitary », la minuterie démarre lors de l'allumage de l'éclairage, même si la détection de présence est désactivée. Une commande en fonction du temps est ainsi possible même lors d'une utilisation purement manuelle.

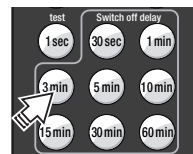

1. Appuyer sur [Switch off delay 3 min] (SP) pour régler une temporisation de 3 minutes pour CH-1 et CH-2.

(F)
(B)

5.6 Fonction de test

La fonction de test sert à contrôler la zone de détection de la cellule

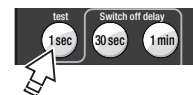

1. Appuyer sur **[test]** (SP) pour activer la fonction de test.
2. Appuyer sur **[PROG]** (SP) pour démarrer le test.
3. Accès de la zone de détection :
 - en cas de détection 100% ON,
 - sans détection après 1 s retour à 1% ON.
4. Le cas échéant, modifier la zone de détection en réglant les obturateurs de la cellule et répéter les étapes 3 et 4 aussi souvent que nécessaire.
5. Une fois le test réussi, attendre 60 secondes ou appuyer auparavant sur **[ON/OFF]** ou **[CH-1/CH-2]** (SP), pour désactiver la fonction de test (retour à la fonction normale).

5.7 Stand-by-level

Régler la clarté en (%) dans STANDBY ou désactiver la fonction STANDBY.

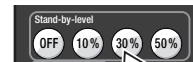

1. Par exemple appuyer sur **[Stand-by-level 30%]** (SP ou LP), pour régler le stand-by pour CH-1 (CH-2 suit le cas échéant avec OFFSET ▶ 5.10).

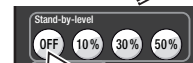

2. Appuyer sur **[Stand-by-level OFF]** (SP ou LP), pour désactiver la fonction STANDBY.

5.8 Stand-by-time

Régler la durée du STANDBY ou activer durablement la fonction STANDBY.



- Appuyer sur l'une des touches [Stand-by-time] (SP ou LP), pour régler la durée du STANDBY pour CH-1 et CH-2. Si [Stand-by-time ∞] est sélectionné, l'éclairage ne s'éteint jamais.

5.9 Fonctions lumière du jour et présence

Les fonctions lumière du jour et présence :

- peuvent être réglées ensemble pour toutes les cellules raccordées (mode PROG ► 5.1)
- pour chaque cellule individuelle (Sensor select ► 5.12).

Fonctions lumière du jour

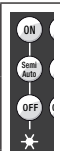
	Bouton [ON]	<ul style="list-style-type: none"> Réglage de la lumière du jour entièrement automatique actif
	Bouton [Semi Auto]	<ul style="list-style-type: none"> Extinction automatique en cas de lumière du jour trop importante Allumage manuel
	Touche [OFF]	<ul style="list-style-type: none"> Réglage de la lumière du jour éteint

Fonctions de présence

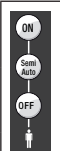
	Touche [ON]	<ul style="list-style-type: none"> Détection de présence active
	Touche [Semi Auto]	<ul style="list-style-type: none"> Passage automatique en « STANDBY » ou « OFF » à la fin de la durée de temporisation Allumage manuel
	Touche [OFF]	<ul style="list-style-type: none"> Détection de présence éteinte

5.10 Régler l'offset

Régler l'OFFSET (= distance de CH-2 à CH-1) d'un mode de fonctionnement particulier.



- Appuyer sur **[Offset]** (SP).

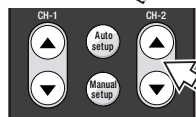

- L'offset est réglé avec la touche à bascule **[CH-2]** :
 - LP = réglage approximatif
 - SP = réglage fin

L'offset de CH-2 peut être de :

- min. = valeur de CH-1
- max. = 100 % clarté

- Appuyer sur **[Offset]** (SP) pour enregistrer le réglage.

5.11 100 h Burn-in

En cas d'utilisation de lampes fluorescentes, le mode de fonctionnement stable et la durée de vie maximale ne sont garantis qu'après une phase d'allumage (100 h à 100 %). Pendant l'allumage, toutes les fonctions automatiques sont éteintes, toutes les lampes sont allumées à 100 %.

Les LED de toutes les cellules raccordées restent allumées en rouge.

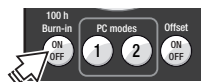

- Lors de la mise en service ou de l'utilisation régulière du système, appuyer sur **[100 h Burn-in ON/OFF]** (SP) pour démarrer le processus.
- Appuyer de nouveau sur **[100 h Burn-in ON/OFF]** (SP) pour le cas échéant achever prématurément le processus.

Après toute consultation de fonction, une minuterie de 100 h démarre.

5.12 Sensor select



1. Appuyer sur **[Sensor select]** (LP), pour sélectionner une cellule (la LED de la cellule sélectionnée clignote en orange).
Affichage LED sur la cellule :
 - Orange = cellule sélectionnée
 - Rouge = fonction présence active
 - Vert = fonction lumière du jour active
2. Effectuer les réglages de la cellule ► 5.9.
3. S'il y a plusieurs cellules dans le système, appuyer de nouveau sur **[Sensor select]** (SP) pour sélectionner la cellule suivante.
4. Appuyer sur **[Sensor select]** (LP) pour enregistrer les réglages de la cellule ou sur **[PROG]** (SP).

5.13 PC modes



Sans fonction.

5.14 Macro Recorder



Sans fonction.

6 Utilisation du système avec User Remote

En appuyant sur User Remote, toujours pointer vers la cellule correspondante.

6.1 Touches scène [1] à [4] ► 7

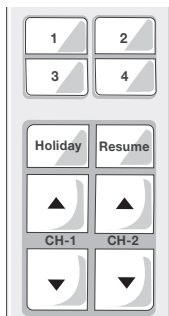

- **Consulter une scène** : Sélection de la scène de lumière enregistrée en appuyant sur la touche (SP).
- **Enregistrer une scène** : Une puissance d'éclairage modifiée manuellement avec **[CH-1]** et/ou **[CH-2]** peut être enregistrée en appuyant sur (LP) sur la touche scène correspondante (le système clignote pour confirmer).
- **Bloquer ou valider de nouveau l'enregistrement de la scène** :
 1. - Appuyer en même temps sur **[Holiday]+[CH-2 ▲]** (VLP) (la LED rouge clignote).
 2. - Appuyer sur **[1]** (SP) pour bloquer l'enregistrement d'une scène (la LED s'allume en rouge pendant trois secondes)
 - Appuyer sur **[2]** (SP) (SP) pour valider l'enregistrement de la scène (la LED s'allume en vert pendant trois secondes).



6.2 Bouton [Holiday]

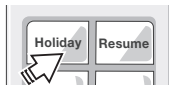

Désactivation temporaire de la détection de présence en appuyant sur (SP), la LED de la cellule reste allumée en rouge.
Réactivation possible avec les touches **[ON/OFF]** des touches scène **[1] à [4]** et **[CH-1]/[CH-2]**.

6.3 Bouton [Resume]

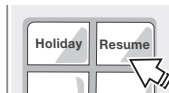

Reprise de la fonction de commande de lumière automatique en appuyant sur le bouton (SP). Concernant les modes de fonctionnement sans réglage de la lumière, cette touche n'a aucune fonction.

6.4 Utilisation indépendante de plusieurs systèmes

Adapter l'User Remote à un récepteur précis sélectionné pour une utilisation indépendante de plusieurs systèmes (maximal 15) dans une même pièce.



- Appuyer en même temps sur **[CH-1 ▼]** + **[CH-2 ▼]** (VLP) pour démarrer une programmation individuelle (La LED clignote en rouge).
- Activer le pavé numérique (réglage d'usine = 16) :
 - Pavé numérique 1-4 : appuyer sur **[1]** (SP).
 - Pavé numérique 5-8 : appuyer sur **[2]** (SP).
 - Pavé numérique 9-12 : appuyer sur **[3]** (SP).
 - Pavé numérique 13-16 : appuyer sur **[4]** (SP).
- Programmer le numéro système :
 - Appuyer sur **[1], [2], [3]** ou **[4]** (SP) pour le numéro système à programmer (réglage d'usine = 16) (la LED verte clignote deux fois et le système clignote pour confirmer).

--> Exemple : Programmer le numéro système 10 :

- Appuyer en même temps sur **[CH-1 ▼]** + **[CH-2 ▼]** (VLP) (la LED clignote en rouge).
- Appuyer sur **[3]** (SP) pour activer le pavé numérique 9-12.
- Appuyer sur **[2]** (SP) pour programmer le numéro système 10 (la LED verte clignote deux fois et le système clignote pour confirmer).

7 Réinitialisation

7.1 System Reset (avec Master Remote)

- Appuyer sur **[PROG]** (LP) pour démarrer le mode de programmation (la LED1 clignote).
- Appuyer sur **[Single Office]** (SP) pour régler le mode de fonctionnement par défaut (la LED1 clignote rapidement).
- Appuyer sur **[PROG]** (SP) pour quitter le mode de programmation.

7.2 Reset Master Remote

- Appuyer sur **[PROG]** (LP) pour démarrer le mode de programmation (la LED1 clignote).
- Appuyer en même temps sur (VLP) de **[Corridor]** et **[Staircase]** (la LED2 clignote).
- Appuyer sur **[PROG]** (LP) – (les LED1 et LED2 s'allument en orange pendant 3 secondes).

7.3 Reset User Remote

- Appuyer en même temps sur (VLP) de **[CH-1 ▲]** et **[Resume]** (la LED clignote en rouge).
- Appuyer sur **[4]** (SP) – (la LED clignote en orange pendant 3 secondes).

8 Caractéristiques techniques











Raccordement électrique	220 – 240 V CA 50-60 Hz
Entrée boutons	Contacts de fermeture sans potentiel Longueur de câble max. 50 m
Sorties de charge (de commande)	Selon IEC 62386 idem DA1+/- / DA2+/-
Courant de commande	max. 64 mA (par canal) max. 96 mA (somme des deux canaux) Longueur de câble max. 100 m (par canal)
Branchement des cellules	DALIeco LS/PD LI = max. 4x DALIeco LS/PD LI HF = max. 1x Longueur de câble max. 25 m, en cas de rallonge/raccourcissement assurer une affectation des contacts 1:1
Puissance consommée	0,2 W - 3,0 W (selon le fournisseur d'électricité/nombre de cellules)
Température ambiante	-20 °C à +50 °C (service)
Indice de protection	IP20
Classe de protection	II, isolation de protection
Conformité	CE



i Remarque importante :

S'il n'est pas possible de poser séparément les câbles des cellules et des boutons qui sont raccordés directement au système de commande des câbles du réseau et des luminaires, nous recommandons de raccorder les cellules et le bouton-poussoir via une ligne DALI.

DALleco Control - Installazione e uso

Indice

1	Indicazioni generali.....	51
1.1	Simboli e abbreviazioni delle presenti istruzioni.....	51
1.2	Uso conforme a destinazione.....	51
2	Montaggio e installazione.....	51
2.1	Assegnazione dei collegamenti dell'unità di comando 	51
2.2	Dimensioni e misure di montaggio 	51
2.3	Schema di collegamento dei componenti elettrici del sistema 	51
2.4	Sensore e collegamento in rete 	51
2.5	Pulsante esterno 	51
2.6	Collegamento di sensori e pulsanti supplementari attraverso la linea DALI 	51
2.6.1	Integrazione di pulsanti mediante accoppiatori pulsante	52
2.6.2	Integrazione di sensori mediante accoppiatori sensore.....	52
3	Funzione e componenti esterni.....	53
3.1	Modo di funzionamento di principio.....	53
3.2	Comando a due canali DALI 1 / DALI 2	53
3.3	Pulsante esterno 	53
3.4	Comportamento dopo un'interruzione della corrente	53
4	Uso	53
4.1	Telecomando Master Remote  (e ► istruzioni separate).....	53
4.2	Telecomando User Remote  (e ► istruzioni separate)	54
4.3	Accensione/spengimento del sistema	54
4.4	Dimming del sistema	54
5	Programmazione del sistema passo a passo con Master Remote.....	54
5.1	Modalità di programmazione (modalità PROG).....	54
5.2	Modalità di funzionamento 	55
5.3	Auto setup	55
5.4	Manual setup	55
5.5	Switch off delay (ritardo di spegnimento)	55
5.6	Funzione di test	55
5.7	Stand-by-level	55
5.8	Stand-by-time.....	56

5.9	 Funzioni luce diurna e  presenza	56
5.10	Regolazione dell'offset	56
5.11	100 h Burn-in.....	56
5.12	Sensor select.....	57
5.13	PC modes.....	57
5.14	Macro Recorder	57
6	Uso del sistema mediante User Remote	57
6.1	Tasti scena da [1] a [4] 	57
6.2	Tasto [Holiday]	57
6.3	Tasto [Resume]	57
6.4	Uso indipendente di più sistemi.....	58
7	Reset.....	58
7.1	Reset del sistema (con Master Remote)	58
7.2	Reset Master Remote.....	58
7.3	Reset User Remote	58
8	Dati tecnici	58

1 Indicazioni generali

1.1 Simboli e abbreviazioni delle presenti istruzioni

- Voce di un elenco, enumerazione
- 1. Fase di lavoro numerata con sequenza prestabilita
- ▶ 2.2 Rimando a sezione (ad es. 2.2) o istruzione separata (in tal caso senza numeri)
- ▶ 14 Rimando a figura (ad es. alla figura 13)

SP Abbreviazione di "Short Press / premere brevemente il tasto" (<0,5 s)

LP Abbreviazione di "Long Press / premere il tasto a lungo" (>0,5 s)

VLP "Very Long Press / premere il tasto molto a lungo" (>10 s)

DP "Double Press / breve doppio azionamento" (di <0,5 s ogni volta)



Simbolo "INFORMAZIONI / NOTA"

1.2 Uso conforme a destinazione

Questo prodotto è stato sviluppato ed è destinato specificamente per l'utilizzo con sistemi di gestione della luce per lampade. Ogni impiego diverso da quello descritto queste nelle presenti istruzioni non è conforme a destinazione.

Simboli utilizzati nei diagrammi

	La lampada è accesa: "ON"		La lampada è spenta: "OFF"
	Accensione automatica dell'illuminazione mediante rilevamento della presenza.		Accensione manuale dell'illuminazione mediante pulsante esterno.
	Ritardo di spegnimento 1: dopo l'uscita dalla zona di rilevamento della presenza.		Ritardo di spegnimento 2

2 Montaggio e installazione

2.1 Assegnazione dei collegamenti dell'unità di comando ▶ 3

- (1) Collegamento alla rete
- (2) Collegamento alla rete
- (3) Non occupato
- (4) DALI 1(-)
- (5) DALI 1(+)
- (6) DALI 2(-)
- (7) DALI 2(+)
- (8) Collegamento sensore (4p4c)
- (9) Ingresso pulsante esterno
- (10) Collegamento Sync (senza funzione)
- (11) GND - potenziale di riferimento pulsante esterno

2.2 Dimensioni e misure di montaggio ▶ 2

2.3 Schema di collegamento dei componenti elettrici del sistema ▶ 4

2.4 Sensore e collegamento in rete ▶ 5

Il sensore è destinato all'integrazione della lampada. Installazione e impostazioni del sensore ▶ istruzioni separate.

Collegamento di max. 4 sensori (3) tramite connettore a Y (4) e cavo sensore (2) al collegamento sensore dell'unità di comando (1).

Requisiti per posizione di sensore e lampada:

- Tutto il posto di lavoro (da sorvegliare) rientra nella zona di sorveglianza del sensore.
- Evitare l'irradiazione diretta del sensore da parte di sorgenti luminose (errori di misurazione).
- Il sensore non deve essere installato in zone con correnti d'aria (impianto di climatizzazione/ventilazione) o sorgenti di calore (fotocopiatrice/termoventilatore) (simulazione del movimento di persone).

2.5 Pulsante esterno ▶ 4

Pulsante per il comando/l'impostazione manuale. Condizioni per il collegamento ▶ 8.

2.6 Collegamento di sensori e pulsanti supplementari attraverso la linea DALI ▶ 6

È possibile integrare sensori e pulsanti supplementari mediante accoppiatori collegabili direttamente alle due linee DALI. Questa funzione è indipendente dal fatto che il collegamento avvenga attraverso il canale DALI 1 o 2. Oltre ai 16 alimentatori elettronici DALI, ad ogni canale DALI è possibile collegare fino a tre accoppiatori.

2.6.1 Integrazione di pulsanti mediante accoppiatori pulsante

È possibile collegare pulsanti alla linea DALI mediante accoppiatori tasti senza ulteriore messa in servizio. Ogni accoppiatore pulsante collegato dispone di quattro ingressi (A-D).

Impostazione di base dell'accoppiatore pulsante

Nell'impostazione di base (= stato alla consegna) tutti gli ingressi/pulsanti hanno la stessa funzione. La funzione corrisponde al pulsante collegato direttamente all'ingresso pulsante della centralina ► 3.3.

Funzione alternativa / assegnazione pulsanti degli accoppiatori pulsante

①

Funzione del pulsante dell'ingresso accoppiatore A:

- **SP:** accensione o spegnimento DALI CH-1 (funzione toggle)
- **LP:** dimming verso l'alto o verso il basso DALI CH-1 (funzione toggle)

Funzione del pulsante dell'ingresso accoppiatore B:

- **SP:** accensione o spegnimento DALI CH-2 (funzione toggle)
- **LP:** dimming verso l'alto o verso il basso DALI CH-2 (funzione toggle)

Funzione del pulsante dell'ingresso accoppiatore C:

- **SP e LP:** accensione o passaggio dallo stato standby allo stato "ON"

Funzione del pulsante dell'ingresso accoppiatore D:

- **SP e LP:** accensione o passaggio dallo stato "ON" allo stato "standby"

Attivazione della funzione alternativa / assegnazione pulsanti degli accoppiatori pulsante

1. Avviare la modalità di programmazione mediante **LP** sul tasto "Prog" (5) del telecomando
2. Attivare Sensor Select mediante **LP** sul tasto (10) del telecomando
3. Azionare un pulsante qualsiasi di quelli collegati all'accoppiatore pulsante
4. L'illuminazione si abbassa al 10 % della luminosità segnalando così l'inizio del procedimento di configurazione
5. Il procedimento si conclude dopo circa 1 minuto (a seconda del numero di accoppiatori)
6. L'illuminazione lampeggia due volte per confermare

Ripristino dell'impostazione iniziale dell'accoppiatore pulsante ► 6

1. Avviare la modalità di programmazione mediante **LP** sul tasto "Prog" (5) del telecomando
2. Attivare Sensor Select con il tasto (10) del telecomando
3. Azionare per più di 10 sec. un pulsante qualsiasi di quelli collegati all'accoppiatore pulsante
4. L'illuminazione si abbassa al 10% della luminosità segnalando così l'inizio del procedimento di ripristino

Al termine dell'operazione di ripristino l'illuminazione passa brevemente al 100%, poi viene impostato di nuovo il valore originario.

2.6.2 Integrazione di sensori mediante accoppiatori sensore

Mediante accoppiatori sensore è possibile collegare sensori alla linea DALI senza ulteriore messa in servizio, il che consente di ampliare la zona di rilevamento della presenza.

Gli indici di luminosità di questi sensori non vengono interpretati.



Nota importante:

Per configurare il comando mediante telecomando a infrarossi è necessario che sia collegato almeno un sensore all'interfaccia sensore della centralina.





Nota importante:

La regolazione in funzione della luce diurna utilizza esclusivamente gli indici di luminosità dei sensori collegati all'interfaccia sensore.

3 Funzione e componenti esterni

3.1 Modo di funzionamento di principio

L'unità di comando cambia/commuta l'illuminazione in posti di lavoro, corridoi e altri spazi comuni in funzione della luce diurna utile e della presenza/del movimento delle persone. Ciò viene rilevato da sensori. In questo modo si aumenta il comfort nel posto di lavoro e si risparmia energia. Esistono modalità di funzionamento per applicazioni/scenari diversi  8. È possibile adeguarli alle proprie necessità  5.

3.2 Comando a due canali DALI 1 / DALI 2

Dopo l'installazione elettrica le lampade possono funzionare su DALI 1 (CH-1) e DALI 2 (CH-2) con indici di luminosità identici o con OFFSET per CH-2  5.10.

3.3 Pulsante esterno 4

L'azionamento di un pulsante esterno ha la priorità rispetto alle funzioni automatiche.

3.4 Comportamento dopo un'interruzione della corrente

Quando la tensione di rete è di nuovo presente, il sistema si trova in uno stato preimpostato in funzione della modalità di funzionamento impostata in precedenza:



Modalità di funzionamento	Stato
Single Office	OFF
Open Plan Office	OFF
Corridor	STANDBY
Meeting-/Classroom	LAST STATE
Sanitary Room	STANDBY
Staircase	STANDBY
Nessuna modalità di funzionamento selezionata	LAST STATE

4 Uso

Descrizione di tutti i pulsanti/LED del Master Remote e delle relative funzioni che non richiedono l'utilizzo del tasto **[PROG]**, nonché descrizione di tutti i pulsanti/LED dell'User Remote e delle loro funzioni.

4.1 Telecomando Master Remote 7 (e istruzioni separate)

Tasti / LED / collegamenti

- (1) **[ON/OFF]** illuminazione on/off
- (2) Segnalazione LED 1 (verde/rosso/arancione)
- (3) **[test]** modalità di test per l'impostazione della zona di rilevamento (1 secondo di ritardo di spegnimento)
- (4) **[Modalità di funzionamento]** selezione
- (5) **[PROG]** modalità di programmazione on/off
- (6) **[100 h Burn-in]** on/off
- (7) **[Auto setup]** attivazione della memorizzazione automatica del valore nominale
- (8) **[CH-1]** regolazione luminosità canale 1 (manale/diretta)
- (9) **[Stand-by-time]** selezione valori predefiniti tempo di STANDBY
- (10) **[Sensor select]** selezione sensore
- (11) Segnalazione LED 2 (verde/rosso/arancione)
- (12) **[Switch off delay]** selezione valori predefiniti ritardo di spegnimento
- (13) **[Macro Recorder]** sequenza di tasti registrazione/memorizzazione/invio
- (14) **[Offset]** impostazione OFFSET on/off
- (15) **[PC modes]** senza funzione
- (16) **[CH-1]** regolazione luminosità canale 2 (manale/diretta)
- (17) **[Manual setup]** regolazione manuale dell'indice di luminosità
- (18) **[Stand-by-level]** selezione valori predefiniti STANDBY
- (19)   selezione funzioni luce diurna/presenza on/semiautomatico/off
- (20) Collegamento mini USB

Segnalazione LED

- LED 1 - lampeggia velocemente quando viene trasmesso il segnale (IR) (verde)
- LED 1 - lampeggia nella modalità "PROG" (rosso)
- LED 1 - è acceso durante la trasmissione USB (arancione)
- LED 2 - lampeggia nella modalità "Sensor Select" (verde)
- LED 1/LED 2 - sono accesi durante il "reset" Master Remote (arancione)

4.2 Telecomando User Remote (e ► istruzioni separate)

Tasti / LED

- (21) **[ON/OFF]** tutte le lampade on/off
- (22) segnalazione LED (verde/rosso/arancione)
- (23) **[1]** tasto scene 1
- (24) **[3]** tasto scene 3
- (25) **[Holiday]** attivazione modalità Holiday
- (26) **[CH-1]** regolazione luminosità canale 1 (manale/diretta)
- (27) **[2]** tasto scene 2
- (28) **[4]** tasto scene 4
- (29) **[Resume]** ripresa della funzione luce diurna automatica
- (30) **[CH-1]** regolazione luminosità canale 2 (manale/diretta)

Segnalazione LED (22)

- verde - lampeggia velocemente quando viene trasmesso il segnale (IR)
- rosso - lampeggia nella modalità "Memorizzazione"
- arancione - è acceso durante il "reset" User Remote

4.3 Accensione/spengimento del sistema



Pulsante esterno:

1. Premere il pulsante esterno (SP) per accendere o spegnere la lampada.



Master Remote e User Remote:

1. Premere il tasto **[ON/OFF]** (SP) per accendere o spegnere CH-1 (DALI 1) e CH-2 (DALI 2).

4.4 Dimming del sistema



Pulsante esterno:

1. Premere il pulsante esterno (LP) per aumentare o ridurre la luminosità dei due canali.

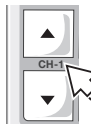

Master Remote e User Remote:

1. Mantenere premuto in alto/in basso **[CH-1]** o **[CH-2]** per aumentare/ridurre in modo indipendente la luminosità dei canali DALI 1 e DALI 2.

5 Programmazione del sistema passo a passo con Master Remote

La programmazione o configurazione avvengono per mezzo del Master Remote o direttamente dal sensore.

Quando si premono i tasti, puntare sempre il Master Remote verso il sensore in questione.

Passo 1	Attivazione della modalità PROG	Modalità di programmazione ► 5.1
Passo 2	Selezione della modalità di funzionamento	Modalità di funzionamento ► 5.2
Passo 3	Preimpostazione del valore nominale per la regolazione della luce	Auto setup ► 5.3 o Manual setup ► 5.4
Passo 4	Adeguamento individuale della modalità di funzionamento selezionata	Ritardo di spegnimento ► 5.5 Funzione di test ► 5.6 Stand-by-level ► 5.7 Stand-by-time ► 5.8 Funzioni luce diurna e presenza ► 5.9
Passo 5	Adeguamento dell'indice di luminosità per il canale 2 (CH-2)	Offset ► 5.10
Passo 6	Funzioni speciali	100 h Burn-in ► 5.11 Sensor select ► 5.12 PC modes ► 5.13 Macro Recorder ► 5.14

5.1 Modalità di programmazione (modalità PROG)



1. Premere il tasto **[PROG]** (LP) per attivare la modalità di programmazione (il LED 1 lampeggia). CH-1 / CH-2 vengono regolati sull'ultimo valore nominale memorizzato (default = 80%).
2. Programmazione passo a passo, spiegata nelle sezioni da ► 5.1 a ► 5.14 (sono possibili più funzioni/impostazioni consecutive).
3. Premere il tasto **[PROG]** (SP) per memorizzare le impostazioni e uscire dalla modalità di programmazione.

Se non si esce appositamente dalla modalità PROG, le impostazioni diventano attive dopo 60 secondi. La modalità PROG termina automaticamente 60 secondi dopo l'ultimo azionamento di un tasto.

5.2 Modalità di funzionamento ▶ 8

Comportamento di commutazione delle modalità di funzionamento preconfigurate: Diagrammi da

▶ 9 a ▶ 14.



- Single Office ▶ 9
- Open-plan Office ▶ 10
- Corridor ▶ 11
- Meeting- / Classroom ▶ 12
- Sanitary Room ▶ 13
- Staircase ▶ 14

5.3 Auto setup

Imposta il valore della regolazione della luce sull'80% dell'intensità di illuminazione massima.

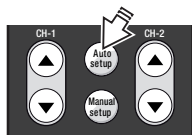

1. Premere il tasto [Auto setup] (SP) per avviare la calibrazione. Dopo una calibrazione di 3 minuti l'illuminazione lampeggia e si avvia la regolazione automatica della luce.
Nota: durante "AutoSet Up" non sono possibili impostazioni. La modalità "Prog" termina automaticamente una volta eseguito "AutoSet Up".

5.4 Manual setup

Memorizza il valore nominale su un valore impostabile a piacere.

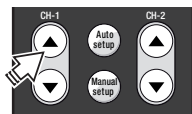

1. Premere il tasto a bilanciere [CH-1] in alto/in basso per impostare il valore nominale per la regolazione.

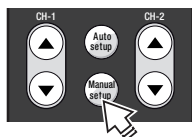

2. Premere il tasto [Manual setup] (SP) per memorizzare l'intensità di illuminazione attuale come valore nominale (le lampade lampeggiano).



Nota:

Se la regolazione della luce è disattivata, ogni 2000 ore di accensione la centralina aumenta il valore di luminosità memorizzato di un passo, compensando così automaticamente l'invecchiamento delle lampadine. Quando si cambia la lampadina è necessario memorizzare di nuovo il valore nominale per riavviare l'operazione.

5.5 Switch off delay (ritardo di spegnimento)

Il timer viene impostato dopo l'ultimo rilevamento della presenza fino all'uscita dallo stato "ON" (passaggio a "STANDBY" o "OFF"). Nelle modalità di funzionamento "Corridor", "Staircase" e "Sanitary" il timer si avvia all'accensione dell'illuminazione anche se il rilevamento della presenza è disattivato. In questo modo è possibile un comando in funzione del tempo anche in caso di uso esclusivamente manuale.

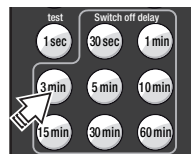

1. Premere il tasto [Switch off delay 3 min] (SP) per impostare un ritardo di spegnimento di 3 minuti per CH-1 e CH-2.

5.6 Funzione di test

La funzione di test consente di verificare la zona di rilevamento del sensore.

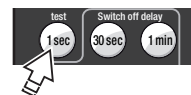

1. Premere il tasto [test] (SP) per attivare la funzione di test.
2. Premere il tasto [PROG] (SP) per avviare il test.
3. Entrare nella zona di rilevamento:
 - in caso rilevamento, 100% ON,
 - senza rilevamento, dopo 1 sec. ritorno a 1% ON.
4. Se necessario modificare la zona di rilevamento regolando i diaframmi del sensore e ripetere i passi 3. e 4. secondo necessità.
5. Se il test riesce, attendere 60 secondi o premere prima il tasto [ON/OFF] o [CH-1/CH-2] (SP) per disattivare la funzione di test (ritorno alla funzione normale).

5.7 Stand-by-level

Regolare la luminosità (%) in STANDBY o disattivare la funzione STANDBY.

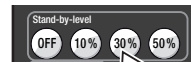

1. Ad esempio premere il tasto [Stand-by-level 30%] (SP o LP) per impostare lo STANDBY per CH-1 (CH-2 segue eventualmente con OFFSET ▶ 5.10).

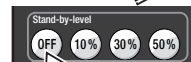

2. Premere il tasto [Stand-by-level OFF] (SP o LP) per disattivare la funzione STANDBY.

5.8 Stand-by-time

Impostare la durata dello STANDBY o attivare permanentemente la funzione STANDBY.



- Premere uno dei tasti [Stand-by-time] (SP o LP) per impostare il tempo di STANDBY per CH-1 e CH-2.
Se si seleziona [Stand-by-time ∞], l'illuminazione non si spegne mai.

5.9 Funzioni luce diurna e presenza

Le funzioni luce diurna e presenza possono essere impostate:

- per tutti i sensori collegati insieme (modalità PROG ► 5.1)
- singolarmente per ogni sensore (Sensor select ► 5.12)

Funzioni luce diurna

	Tasto [ON]	<ul style="list-style-type: none"> • Regolazione automatica in funzione della luce diurna attiva
	Tasto [Semi Auto]	<ul style="list-style-type: none"> • Spegnimento automatico in presenza di luce diurna eccessiva • Accensione manuale
	Tasto [OFF]	<ul style="list-style-type: none"> • Regolazione in funzione della luce diurna disattivata

Funzioni presenza

	Tasto [ON]	<ul style="list-style-type: none"> • Rilevamento della presenza attivo
	Tasto [Semi Auto]	<ul style="list-style-type: none"> • Passaggio automatico a "STANDBY" o "OFF" allo scadere del ritardo di spegnimento • Accensione manuale
	Tasto [OFF]	<ul style="list-style-type: none"> • Rilevamento della presenza disattivato

5.10 Regolazione dell'offset

Regolare l'OFFSET (= intervallo da CH-2 a CH-1) di una determinata modalità di funzionamento.



1. Premere il tasto **[Offset]** (SP).

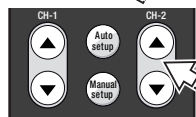

2. L'offset si regola tramite il tasto a bilanciere **[CH-2]**:
- LP = regolazione di massima
- SP = regolazione di precisione

L'offset di CH-2 può presentare i seguenti valori:

- min. = valore di CH-1
- max. = 100% di luminosità

3. Premere il tasto **[Offset]** (SP) per memorizzare l'impostazione.

5.11 100 h Burn-in

Se si utilizzano lampada fluorescenti, la stabilità di funzionamento e la massima vita utile sono garantite solo dopo una fase di rodaggio (100 ore al 100%). Durante il rodaggio tutte le funzioni automatiche sono disattivate e tutte le lampade del sistema sono accese con una potenza del 100%. I LED di tutti i sensori collegati sono accesi con luce rossa fissa.

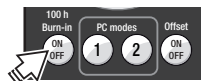

1. Alla messa in servizio o prima dell'utilizzo regolare del sistema, premere il tasto **[100 h Burn-in ON/OFF]** (SP) per avviare il processo.
2. Premere nuovamente il tasto **[100 h Burn-in ON/OFF]** (SP) per concludere eventualmente il processo prima del tempo.

Ogni richiamo della funzione riavvia il periodo di 100 ore.

5.12 Sensor select



1. Premere il tasto **[Sensor select]** (LP) per selezionare un sensore (il LED del sensore selezionato lampeggia in arancione).
Indicazione LED del sensore:
 - Arancione = sensore selezionato
 - Rosso = funzione presenza attiva
 - Verde = funzione luce diurna attiva
2. Eseguire le impostazioni del sensore ► 5.9.
3. Se il sistema dispone di più sensori, premere nuovamente il tasto **[Sensor select]** (SP) per selezionare il sensore successivo.
4. Premere il tasto **[Sensor select]** (LP) per memorizzare le impostazioni del sensore o premere il tasto **[PROG]** (SP).

5.13 PC modes



Senza funzione.

5.14 Macro Recorder



Senza funzione.

6 Uso del sistema mediante User Remote

Quando si premono i tasti, puntare sempre l'User Remote verso il sensore in questione.

6.1 Tasti scena da [1] a [4] ► 7

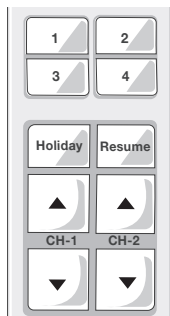

- **Richiamo di una scena:** selezione della scena di luce memorizzata mediante pressione del tasto (SP).
- **Memorizzazione di una scena:** l'intensità di illuminazione modificata manualmente mediante **[CH-1]** e/o **[CH-2]** può essere memorizzata premendo (LP) il tasto scena in questione (il sistema lampeggia per confermare).
- **Bloccare o sbloccare nuovamente la memorizzazione della scena:**
 1. - Premere contemporaneamente i tasti **[Holiday]+[CH-2 ▲]** (VLP) (il LED rosso lampeggia).
 2. - Premere il tasto **[1]** (SP) per bloccare la memorizzazione della scena (il LED si accende con luce rossa per tre secondi)
 - Premere il tasto **[2]** (SP) per sbloccare la memorizzazione della scena (il LED si accende con luce verde per tre secondi).

1

6.2 Tasto [Holiday]

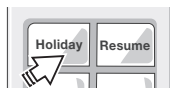

Disattivazione temporanea del rilevamento della presenza mediante pressione del tasto (SP), il LED del sensore resta acceso con luce rossa fissa.

Riattivazione mediante tasti **[ON/OFF]**, possibilità di usare i tasti scena da **[1]** a **[4]** e **[CH-1]/[CH-2]**.

6.3 Tasto [Resume]

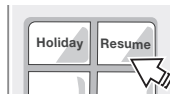

Ripresa della funzione automatica di gestione della luce mediante pressione del tasto (SP). Nelle modalità di funzionamento senza regolazione della luce questo tasto non riveste alcuna funzione.

6.4 Uso indipendente di più sistemi

Sintonizzazione dell'User Remote su un determinato ricevitore selezionato, in modo da consentire l'uso indipendente di più sistemi (massimo 15) nello stesso ambiente.



1. Premere contemporaneamente i tasti **[CH-1 ▼]** + **[CH-2 ▼]** (VLP) per avviare la programmazione individuale (il LED rosso lampeggia).
2. Attivare il tastierino numerico (impostazione di fabbrica = 16):
 - Tastierino numerico 1-4: premere il tasto **[1]** (SP).
 - Tastierino numerico 5-8: premere il tasto **[2]** (SP).
 - Tastierino numerico 9-12: premere il tasto **[3]** (SP).
 - Tastierino numerico 13-16: premere il tasto **[4]** (SP).
3. Programmare il numero di sistema:
 - Premere il tasto **[1]**, **[2]**, **[3]** o **[4]** (SP) per il numero di sistema da programmare (impostazione di fabbrica = 16) (il LED verde lampeggia due volte a modo di conferma).

--> Esempio: programmare il numero di sistema 10:

1. Premere contemporaneamente i tasti **[CH-1 ▼]** + **[CH-2 ▼]** (VLP) (il LED rosso lampeggia).
2. Premere il tasto **[3]** (SP) per attivare il tastierino numerico 9-12.
3. Premere il tasto **[2]** (SP) per programmare il numero di sistema 10 (il LED verde lampeggia due volte e il sistema lampeggia per confermare).

7 Reset

7.1 Reset del sistema (con Master Remote)

1. Premere il tasto **[PROG]** (LP) per avviare la modalità di programmazione (il LED 1 lampeggia).
2. Premere **[Single Office]** (SP) per impostare la modalità di funzionamento di default (il LED 1 lampeggia velocemente).
3. Premere il tasto **[PROG]** (SP) per uscire dalla modalità di programmazione.

7.2 Reset Master Remote

1. Premere il tasto **[PROG]** (LP) per avviare la modalità di programmazione (il LED 1 lampeggia).
2. Premere contemporaneamente (VLP) **[Corridor]** e **[Staircase]** (il LED 2 lampeggia).
3. Premere il tasto **[PROG]** (LP) – (il LED 1 e il LED 2 si accendono con luce arancione per 3 secondi).

7.3 Reset User Remote

1. Premere contemporaneamente (VLP) **[CH-1 ▲]** e **[Resume]** (il LED rosso lampeggia).
2. Premere il tasto **[4]** (SP) – (il LED si accende con luce arancione per 3 secondi).

8 Dati tecnici

Collegamento alla rete elettrica	220 – 240 V AC 50-60 Hz
Ingresso pulsante	Contatti di chiusura a potenziale zero, lunghezza max del cavo 50 m
Uscite (di comando) carico DA1+/- / DA2+/-	a norma IEC 62386 idem
Corrente di comando	Max. 64 mA (a canale) Max. 96 mA (somma dei due canali) Lunghezza max del cavo 100 m (a canale)
Collegamento sensori	DALLecco LS/PD LI = max. 4x DALLecco LS/PD LI HF = max. 1x Lunghezza max del cavo 25 m, in caso di prolungamento/ accorciamento assicurare un'assegnazione 1:1 dei contatti
Potenza assorbita	0,2 W - 3,0 W (a seconda del numero di alimentatori elettronici/sensori)
Temperatura ambiente	Da -20 °C a +50 °C (funzionamento)
Tipo di protezione	IP20
Classe di protezione	II, isolamento di protezione
Conformità	CE



Nota importante:

Qualora non fosse possibile posare i cavi dei sensori e dei pulsanti direttamente collegati alla centralina separatamente dai cavi di rete e delle lampade, si raccomanda di collegare i sensori e i pulsanti tramite la linea DALI.



OSRAM GmbH
Steinerne Furt 62
86167 Augsburg, Germany
www.osram.com

C10504921 | c10505024

LED



Sicherheitshinweise

(D)



Safety Information

(GB)



Consignes de sécurité

(F)



Allgemeine Sicherheitshinweise

- Montage, Inbetriebnahme und Wartung nur durch Elektrofachkraft.
- Arbeiten Sie nie bei anliegender Spannung an der Leuchte. Lebensgefahr durch Stromschlag!
- Elektrischer Anschluss muss ordnungsgemäß, entsprechend allen geltenden Normen und sonstigen nationalen und internationalen Sicherheits- und Unfallverhütungsvorschriften erfolgen.
- Beschädigte Leuchten dürfen nicht betrieben werden.
- Sicherheitshinweise und Montageanleitung beachten und aufbewahren
- Keine Haftung für Schäden durch unsachgemäßen Einsatz.
- Bei Instandsetzung nur Originalteile verwenden.
- Tragfähigkeit der Decke und Befestigungselemente sicherstellen.
- Leuchte ausschließlich für Innenraumeinsatz und Umgebungstemperaturen bis 25°C geeignet, sofern mittels Etikettierung der Leuchte nicht anders beschrieben.



Betrieb der Leuchte

- Ungewöhnliche Dunkelstellen können auf Teilausfall von LED hinweisen. Regelmäßig prüfen und betroffene Leuchten austauschen. Die Lichtquelle (LED) dieser Leuchte darf nicht durch den Anwender ausgetauscht oder ersetzt werden.
- Eine Überschreitung der zulässigen Umgebungstemperatur reduziert die Lebensdauer der Leuchte, im Extremfall droht Frühausfall.
- Die Betauung der Leuchte ist zu vermeiden.
- Jegliche mechanische Belastung der LED Platinen ist unzulässig.
- LED können durch elektrostatische Entladung (ESD) geschädigt werden, bis hin zum Totalausfall. Direkte Berührung ist stets zu vermeiden.
- In Abhängigkeit von deren Konzentration können Chemikalien die LED-Module angreifen und zu Lichtstromreduktion, Drift der Lichtfarbe bzw. Totalausfall führen. Direkter Kontakt mit Säuren, Laugen, Lösemitteln, flüchtigen organischen Verbindungen bzw. Ölen ist stets zu vermeiden. Um Schäden durch Ausgasungen zu vermeiden, ist eine ausreichende Be- und Entlüftung zu gewährleisten.
- Zur Vermeidung von EMV-Problemen Durchgangsverdrahtung nicht unmittelbar entlang der Leuchtenverdrahtung führen.
- Steuereingänge von dimmbaren Leuchten mit handelsüblichen für Netzspannung geeigneten Leitungen anschließen.



Änderungen unserer Produkte

Veränderung, Umarbeitung, Umkenzeichnung von Produkten können deren technische Eigenschaften negativ beeinflussen, diese zerstören und möglicherweise Folgeschäden an anderen Objekten verursachen. Für durch derartige Änderungen verursachte Schäden kann der Hersteller nicht verantwortlich gemacht werden.

- ▽+ IP5x - nicht leitfähiger Staub
- ▽+ IP6x - leitfähiger und nicht leitfähiger Staub



General Safety Information

- Installation, commissioning and maintenance only by qualified electrician.
- Never perform any work on the luminaire with voltage applied. Danger to life due to electric shock!
- Electric connection must be appropriate according to all applicable standards and other national and international safety and accident prevention regulations.
- Damaged luminaires must not be operated.
- Observe and retain safety instructions and mounting instructions
- No liability is accepted for damages resulting from improper use.
- Use genuine parts only for repair.
- Ensure stability of the ceiling and fastening elements.
- The luminaire is exclusively intended for interior rooms and ambient temperatures not exceeding 25°C, unless otherwise described by labeling the luminaire.



Operation of the luminaire

- Abnormal dark spots may be an indication of partial failure of LEDs. Inspect regularly and replace the luminaires affected. The light source (LED) of this luminaire must not be exchanged or replaced by the user.
- Exceeding the permissible ambient temperature will reduce the luminaire's lifecycle, resulting in premature failure in extreme cases.
- Avoid condensation of the luminaire.
- Any mechanical load to the LED circuit boards is not permitted.
- LEDs can be damaged by electrostatic discharge (ESD). This may result in total failure. Always avoid direct contact.
- Depending on their concentration, chemicals can corrode the LED modules and lead to reduction of luminous flux, drift of luminous colour and/or total failure. Always avoid direct contact with acids, bases, solvents, volatile organic compounds and/or oils. Ensure sufficient ventilation to prevent damage by gas release.
- Avoid ESD problems by not routing feed-through wiring directly along the wiring of the luminaire.
- Connect control inputs of dimmable luminaires with standard cables suitable for power supply voltage.



Changes to our products

Modification, reworking, re-marking of products can have a negative impact on their technical properties, destroy them and possibly cause consequential damage to other objects. The manufacturer cannot be held responsible for damage caused by such changes.

- ▽+ IP5x - dust nonconductive
- ▽+ IP6x - dust conductive and dust nonconductive



Consignes générales de sécurité

- Montage, mise en service et maintenance uniquement par un électricien spécialisé.
- Ne travaillez jamais sur un luminaire sous tension. Danger de mort par choc électrique !
- Le branchement électrique doit être réalisé de manière correcte et conforme à toutes les normes en vigueur et autres prescriptions nationales et internationales relatives à la sécurité et à la prévention des accidents.
- Ne pas faire fonctionner de luminaires défectueux.
- Respecter et conserver les consignes de sécurité et les instructions de montage
- Nous déclinons toute responsabilité en cas de dommages dus à une utilisation incorrecte.
- Utiliser uniquement des pièces d'origine pour la réparation.
- Veiller à ce que la capacité portante du plafond et des éléments de fixation soit suffisante.
- Sauf indication contraire indiquée sur l'étiquette du luminaire, luminaire conçu uniquement pour une utilisation en intérieur et une température ambiante maximale de 25 °C.



Fonctionnement du luminaire

- Des zones d'ombre inhabituelles peuvent indiquer un défaut partiel des LED. Contrôler régulièrement et remplacer les luminaires concernés. Utilisateur n'est pas autorisé à échanger ou à remplacer la source de lumière (LED) de ce luminaire.
- Le dépassement des températures ambiantes admissibles réduit la longévité du luminaire; dans les cas extrêmes, cela peut entraîner des pannes prématurées.
- Éviter toute condensation sur le luminaire.
- Ne jamais soumettre les platines à LED à des charges mécaniques.
- Les décharges électrostatiques (DES) peuvent endommager les LED et entraîner leur destruction totale. Toujours éviter le contact direct.
- En fonction de leur concentration, les produits chimiques peuvent attaquer les modules à LED et entraîner une baisse du flux lumineux, une dérive de la température de couleur voire une panne totale. Toujours éviter le contact direct avec les acides, les lessives alcalines, les solvants, les composés et huiles organiques volatils. Assurer une ventilation et une aération suffisantes pour éviter les dégâts dus aux dégagements de gaz.
- Pour éviter les problèmes de CEM, ne pas poser le câblage de liaison directement à côté du câblage du luminaire.
- Brancher les entrées de commande des luminaires à gradation à l'aide de câbles standard adaptés à la tension secteur.



Modification de nos produits

La modification, la transformation et la modification de marquage des produits peuvent avoir une influence négative sur leurs propriétés techniques, détériorer les produits et causer des dommages indirects sur d'autres objets. Le fabricant ne saurait être tenu responsable des dommages causés par ces modifications.

- ▽+ IP5x - non conductrice de la poussière
- ▽+ IP6x - poussière conductrice et de la poussière non conductrice

Information für Wartung, Reinigung und Entsorgung von LED-Leuchten Information for service, cleaning and disposal of luminaire

Instruktion für Wartung von Leuchten: Instruction for luminaire service:

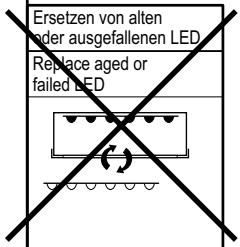

Instruktion für Ende der Lebensdauer:

Instruction for end of life :

Ausschalten, Stromzufuhr zur Leuchte unterbrechen
Switch off, switch off supply to luminaire

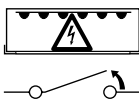

Batterie entfernen zur Entsorgung
Remove battery for disposal

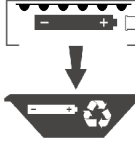

Leuchte entfernen zur Entsorgung
Remove luminaire for disposal

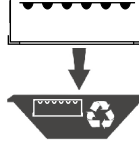

Das Material an WEEE Entsorgungsstelle liefern
Dispatch materials to WEEE recycling plant

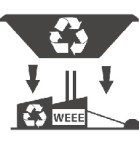

Instruktion für Reinigung von Leuchten: Instruction for luminaire cleaning

Leuchte reinigen
Clean luminaire

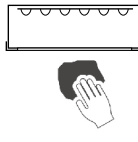

Ausschalten, Stromzufuhr zur Leuchte unterbrechen
Switch off, switch off supply to luminaire

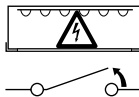

Leuchte außen reinigen
Clean outside luminaire

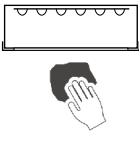

Optik entfernen
Remove optic

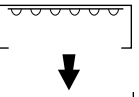

Nur bei SELV! Only SELV!
Leuchte innen reinigen
Clean inside luminaire



Optik wieder anbringen
Refit optic

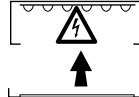

Funktionstest durchführen
Make functional test

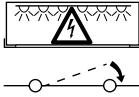

**Advertencias de seguridad**

E

**Avvertenze sulla sicurezza**

I

**Zasady bezpieczeństwa**

PL

**Advertencias de seguridad generales**

- El montaje, la puesta en funcionamiento y el mantenimiento deberán ser realizados exclusivamente por electricistas profesionales.
- No realice nunca trabajos en la luminaria cuando esta esté sometida a tensión. ¡Peligro de muerte por descarga eléctrica!
- La conexión eléctrica se debe realizar de modo reglamentario, de conformidad con todas las normas vigentes y con las demás prescripciones nacionales e internacionales de seguridad y prevención de accidentes.
- Tenga en cuenta las advertencias de seguridad y las instrucciones de montaje y conserve los documentos correspondientes como referencia.
- No se asume ninguna responsabilidad por daños debidos a un uso antirreglamentario.
- Al hacer reparaciones, utilice exclusivamente piezas originales.
- Asegúrese de que el techo y los elementos de fijación tengan la capacidad de carga suficiente.
- A menos que se describa lo contrario etiquetando la luminaria, la luminaria es apta exclusivamente para su uso en interiores y a una temperatura ambiente de hasta 25 °C.

**Funcionamiento de la luminaria**

- La aparición de puntos oscuros inusuales puede ser indicio de la avería de algunos ledes. Realice revisiones periódicas y sustituya las luminarias defectuosas.
- El rebase de la temperatura ambiente permitida conlleva una reducción de la vida útil de la luminaria y, en casos extremos, el riesgo de una avería prematura.
- Se debe evitar la condensación en la luminaria.
- Está prohibida toda carga mecánica sobre las pletinas de los ledes.
- Una descarga electrostática podría provocar daños en los ledes e incluso una avería total. Se deberá evitar siempre el contacto directo con estos.
- Según su grado de concentración, los productos químicos pueden atacar los módulos de ledes y provocar una reducción del flujo luminoso, alteraciones en el tono de la luz o una avería total. Se debe evitar bajo cualquier circunstancia el contacto directo con ácidos, lejías, disolventes, compuestos orgánicos volátiles o aceites. Para evitar daños debidos a las emisiones de gas, es necesario garantizar una ventilación suficiente de entrada y salida.
- Para evitar problemas de compatibilidad electromagnética, no tienda los cables de paso junto a los cables de la luminaria.
- Conecte las entradas de mando de luminarias atenuables mediante cables convencionales adecuados para tensión de red.

Modificaciones de nuestros productos

La modificación, la reelaboración y el remarcado de los productos pueden influir negativamente en sus propiedades técnicas, destruirlos y, posiblemente, causar los consiguientes daños a otros objetos. El fabricante no se hace responsable de los daños causados por dichas modificaciones.

▽+ IP5x - polvo no conductor

▽+ IP6x - polvo conductor y no conductor

**Avvertenze generali sulla sicurezza**

- Il montaggio, l'impiego e la manutenzione devono essere eseguiti solo da un elettricista specializzato.
- Non lavorare mai sulla lampada con tensione elettrica inserita. Pericolo di morte a causa di scossa elettrica!
- L'allacciamento elettrico deve essere eseguito a regola d'arte, in conformità a tutte le norme vigenti, alle disposizioni nazionali e internazionali di sicurezza e alle normative antinfortunistiche.
- Le lampade danneggiate non devono essere utilizzate ulteriormente.
- Osservare e conservare le avvertenze di sicurezza e le istruzioni di montaggio.
- Non lavorare mai sulla lampada con tensione elettrica inserita.
- Per le riparazioni utilizzare solo parti di ricambio originali.
- Verificare la portata del soffitto e degli elementi di fissaggio.
- La lampada è prevista solo per uso interno e temperature ambiente fino a 25 °C, se non diversamente descritto dall'etichettatura dell'apparecchio.

**Funzionamento della lampada**

- Punti scuri insoliti possono indicare un guasto parziale dei LED. Controllare regolarmente e sostituire le lampade in questione.
- Il superamento della temperatura ambiente consentita riduce la durata utile della lampada, in casi estremi si rischia un guasto precoce.
- Evitare la condensazione della lampada.
- È vietata qualsiasi sollecitazione meccanica delle schede LED.
- I LED possono essere danneggiati dalle scariche elettrostatiche (ESD), con possibilità di guasto totale. Si deve sempre evitare il contatto diretto.
- In rapporto alla loro concentrazione, le sostanze chimiche possono aggredire i moduli LED provocando la riduzione del flusso luminoso, la deriva del colore della luce o un guasto totale. Si deve sempre evitare il contatto diretto con acidi, basi, solventi, composti organici volatili o oli. Per evitare danni da emissioni di gas, si deve garantire una sufficiente ventilazione e disaerazione.
- Per evitare problemi di CEM, il cablaggio di transito non deve essere posato direttamente insieme al cablaggio della lampada.
- Collegare gli ingressi di comando delle lampade dimmerabili (varialuce) usando dei cavi adeguati per la tensione di rete.

Modificaciones de nuestros productos

Modifiche, conversioni, cambi dell'etichettatura apportati ai prodotti possono influenzare negativamente le loro proprietà tecniche, distruggerli ed eventualmente causare danni ad altri oggetti. Il produttore non può essere ritenuto responsabile di eventuali danni causati da tali modifiche.

▽+ IP5x - polvere non conduttiva

▽+ IP6x - polvere conduttiva e non conduttiva

**Ogólne zasady bezpieczeństwa**

- Prace związane z montażem, uruchomieniem i konserwacją może wykonywać tylko elektryk.
- Nigdy nie wykonywać prac przy oprawie, gdy znajduje się ona pod napięciem. Niebezpieczeństwo dla życia z powodu porażenia prądem!
- Przyłącze elektryczne musi być wykonane profesjonalnie, zgodnie ze wszystkimi obowiązującymi normami oraz innymi krajowymi i międzynarodowymi przepisami bezpieczeństwa i zapobiegania wypadkom.
- Przestrzegać zasad bezpieczeństwa i wytycznych instrukcji montażu oraz zachować je do późniejszego użytku.
- Producent nie ponosi odpowiedzialności za nieprawidłowe stosowanie.
- W przypadku naprawy używać tylko oryginalnych części.
- Zapewnić nośność sufitu i elementów mocujących.
- Oprawa przeznaczona jest wyłącznie do stosowania w pomieszczeniach w temperaturach otoczenia do 25 °C, o ile nie opisano inaczej, oznaczając oprawę.

**Eksplotacja oprawy**

- Nietypowe zaciemnione miejsca mogą wskazywać na częściową awarię oprawy LED. Należy regularnie dokonywać kontroli i wymieniać uszkodzone oprawy.
- Przekroczenie dopuszczalnej temperatury otoczenia skracza trwałość oprawy, w skrajnym przypadku grozi przedwczesną awarią.
- Unikać obciążenia oprawy.
- Niedopuszczalne jest jakiegokolwiek obciążenie mechaniczne płytek LED.
- Diody LED mogą ulec uszkodzeniu wskutek wyładowania elektrostatycznego (ESD), a nawet ulec całkowitej awarii. Zawsze należy unikać bezpośredniego kontaktu.
- W zależności od stężenia chemikalia mogą uszkodzić moduły LED i prowadzić do obniżenia strumienia światła, zmiany barwy światła lub całkowitej awarii. Zawsze należy unikać bezpośredniego kontaktu z kwasami, ługami, rozpuszczalnikami, lotnymi związkami organicznymi lub olejami. Celem uniknięcia szkód z powodu emisji gazów należy zapewnić odpowiednią wentylację i odpowietrzanie.
- Aby uniknąć problemów EMC, nie prowadzić okablowania przelotowego bezpośrednio wzdłuż okablowania oprawy.
- Wejścia sterujące opraw z funkcją ściemniania podłączać za pomocą dostępnych powszechnie w sprzedaży przewodów odpowiednich od napięcia sieciowego.

Zmiany naszych produktów

Zmiany, przeróbki, modyfikacja oznaczeń produktów mogą mieć negatywny wpływ na ich parametry techniczne, spowodować ich awarię, a także być możliwą przyczyną powstania szkód następczych w innych obiektach. Producent nie odpowiada za szkody spowodowane tego typu modyfikacjami.

▽+ IP5x - pył nieprzewodzący

▽+ IP6x - pył przewodzący i nieprzewodzący

BG



Инструкциите за безопасност на вашия национален език можете да намерите Интернет.

DK



Sikkerhedsinstruktionerne på dit lands sprog findes på Internettet.

EST



Riikliku keele ohutusjuhiseid leiab Internetist.

HR



Sigurnosne upute na vašem nacionalnom jeziku mogu se naći na Internetu.

LV



Drošības norādījumus savā valsts valodā var atrast internetā.

LT



Saugos nurodymus savo valstybine kalba galima rasti internete.

N



Sikkerhetsinstruksjonene på ditt nasjonalspråk finnes på Internett.

P



As instruções de segurança em sua língua nacional podem ser encontradas na Internet.

RO



Instrucțiunile de siguranță din limba dvs. națională pot fi găsite pe Internet.

S



Säkerhetsanvisningarna på ditt nationella språk finns på Internet.

SK



Bezpečnostné pokyny vo vašom národnom jazyku nájdete na internetovej.

SLO



Varnostna navodila v vašem nacionalnem jeziku so na voljo na spletni strani.

CZ



Bezpečnostní pokyny ve vašem národním jazyce naleznete na internetu.

TR



Ulusal dilinizdeki güvenlik talimatları internette.

H



A nemzeti nyelvű biztonsági utasítások megtalálhatók az interneten.

CY



Οι οδηγίες ασφάλειας στην εθνική σας γλώσσα διατίθενται στο διαδίκτυο.

GR

