

## Declaration of Conformity

We, Hytronik Electronics Co., Ltd

3rd Floor, block C, complex building, 155#, Bai'gang road south,

Bai'gang village, Xiao Jin Kou town, Huicheng district, Huizhou, Guangdong, China.

Declare at our sole responsibility, that the devices as following are designed and manufactured is in conformity with the provisions of the following EU Directive(s) and that the standards and /or technical specifications referenced.

|                         |   |
|-------------------------|---|
| Brand:                  | Hytronik  |
| Product models:         | HBP02   |
| Type:                   | Bluetooth touch panel   |
| Relevant EU directives: | 2014/53/EU;<br>2011/65/EU(with amendments EU 2015/863);   |
| Standards complied      | <b>EN 60669-1:2018</b><br><b>EN 60669-2-1:2004/A10:2010</b><br><b>EN IEC 61000-3-2:2019</b><br><b>EN 61000-3-3:2013/A1:2019</b><br><b>EN IEC 55015:2019</b><br><b>EN 61547:2009</b><br><b>EN 300 328 V 2.2.2</b><br><b>EN 301 489-1 V2.2.3</b><br><b>EN 301 489-17 V3.2.4</b><br><b>EN 62479:2010</b> |

We declare as the manufacturer that the mentioned above complies with all essential requirements in the way specified and conforms with the type for which is above mentioned, and be affixed the CE-mark on the product or to the packaging and any accompanying documentation.

Aug.12th,2021

(place and date of issue)



*Simon Xia*











(Test Dep. Manager)( Simon Xia)

## Product Description

A wall-mounted touch panel designed to operate with Hytronik range of Bluetooth products. 6 programmable scene are provided, as well as brightness and tunable white control. In addition, we have added "sensor take over" button and "clean mode" button for better use experience. The HBPO2 is programmable using **Koolmesh™** app.











## App Features

-  Grouping luminaires via mesh network
  - Two levels: room & group
  - Synchronization control
-  7 types of scene options to set up\*
  - Generic Scenes
  - Lux ON/OFF Scenes
  - Daylight Harvest (Open loop)
  - Daylight Harvest (Closed loop)
  - Circadian Rhythm (With daylight sensor)
  - Circadian Rhythm (Without daylight sensor)
  - Time-based Scene
-  Schedule to run scenes based on time and date
-  Astro timer (sunrise and sunset)
-  Floorplan feature to simplify project planning
-  Offline commissioning
-  Different permission levels via authority management
-  Network sharing via QR code or keycode
-  Remote control via gateway support HBGW01
-  Interoperability with Hytronik Bluetooth product portfolio
-  Device firmware update over-the-air (OTA)
-  Continuous development in progress...

\* Certain scenes which require external photocell can be achieved by using together with Hytronik Bluetooth sensors, such as HBIR29, HCD038/BT + sensor head etc.

## Hardware Features

-  Mains powered
-  Designed for electrical box/junction box
-  Keep real time for up to 7-8 weeks against power failure
-  Manual adjustment: on/off, dim and color tuning
-  Manual/Auto display screen brightness adjustment
-  Touch screen with vibration/beeper/LED indication
-  Clean mode/Screen lock time
-  5-year warranty

 **Bluetooth 5.0 SIG mesh**





iOS 10.0 or later





Android 5.0 or later



---



Web app/platform:  
[iot.koolmesh.com](http://iot.koolmesh.com)

## Technical Specifications

| Bluetooth Transceiver  |   |
|------------------------|---|
| Operation frequency    | 2.4 GHz - 2.483 GHz   |
| Transmission power     | 4 dBm   |
| Range (Typical indoor) | 10~30m  |
| Protocol               |  Bluetooth® 5.0 SIG Mesh |
| Environment            |   |
| Operation temperature  | Ta: -20°C ~ +50°C   |
| Relative humidity      | 20% ~ 90%   |
| IP rating              | IP20  |

| Input Characteristics |                                      |
|-----------------------|--------------------------------------|
| Operating voltage     | 220~240VAC 50/60Hz                   |
| Stand-by power        | <1.5W                                |
| Safety & EMC          |                                      |
| EMC standard (EMC)    | EN55015, EN61000, EN61547            |
| Safety standard (LVD) | EN60669-1/-2-1<br>AS/NZS60669-1/-2-1 |
| RED                   | EN300328, EN301489-1/-17             |
| Certification         | CB, CE, EMC, RED, RCM                |

## Mechanical Structure & Dimensions

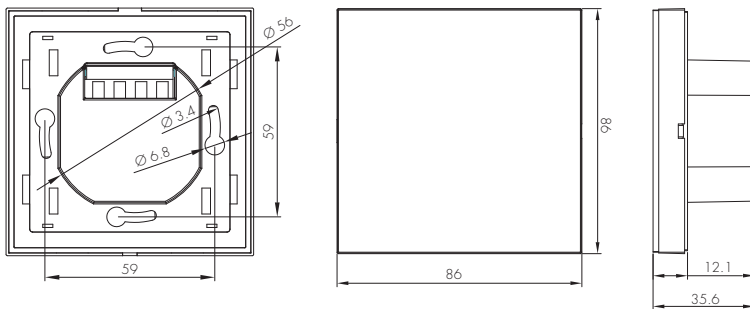

## Wiring Diagram

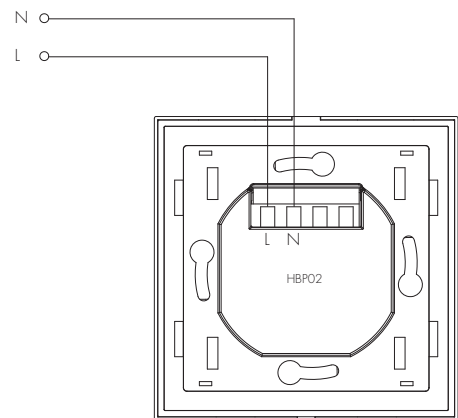

## Wire Preparation



Rising clamp terminal.

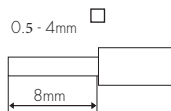

To make or release the wire from the terminal, use a screwdriver to push down the button.

## Operation

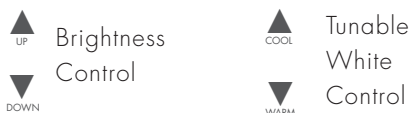

### ① ② ③ ④ Scene Recall

Scenes are simply programmed using the App. Create and name the scenes using the scenes menu, and then assign the scenes to buttons ① ② ③ ④ from the device settings menu.

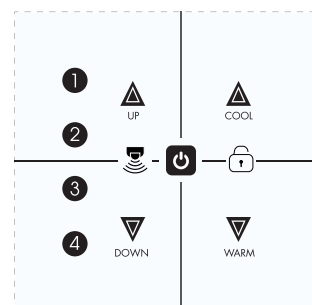



### Senser take over

Press this button to quit manual override mode(Sensors will take over the control).



### Clean Mode

Long press this button for more than 5s to go to clean mode (during this clean mode, the touch panel screen will be locked and does not respond to any touch), it will quit automatically after 1 min.



### The ON/OFF button has a configurable response via the App.

Permanent OFF (Occupancy sensor disabled).

Turning off via the ON/OFF button will suspend the entire system, including occupancy sensor. Pressing this button again will resume the last automatic profile selected, or pressing any other button on the control panel will wake up the system.

### Touch Indications

Three methods for successful touch indications:

Vibration / Beeper / LED indicator

User can select any one, two or all of them to indicate successful touch on HBPO2 in the App.

### Real-time Sustainability

The touch panel HBPO2 can keep the time running for up to 7-8 weeks against power failure.

## Additional Information / Documents

- 1.To learn more about detailed product features/functions, please refer to [www.hytronik.com/download->knowledge ->Introduction of App Scenes and Product Functions](http://www.hytronik.com/download->knowledge ->Introduction of App Scenes and Product Functions)
2. Regarding precautions for Bluetooth product installation and operation, please kindly refer to [www.hytronik.com/download/knowledge ->Bluetooth Products - Precautions for Product Installation and Operation](http://www.hytronik.com/download/knowledge ->Bluetooth Products - Precautions for Product Installation and Operation)
3. Data sheet is subject to change without notice. Please always refer to the most recent release on [www.hytronik.com/products/bluetooth technology ->Bluetooth Accessories](http://www.hytronik.com/products/bluetooth technology ->Bluetooth Accessories)
4. Regarding Hytronik standard guarantee policy, please refer to [www.hytronik.com/download/knowledge ->Hytronik Standard Guarantee Policy](http://www.hytronik.com/download/knowledge ->Hytronik Standard Guarantee Policy)

#### **HYTRONIK ELECTRONICS CO.,LTD**

3rd Floor, block C, complex building, 155#, Bai'gang road south, Bai'gang village  
Xiao Jin Kou town, Huicheng district  
516023 Huizhou  
China