

Achtung – Leuchte mit Notlicht-Einzelversorgung:

Attention – luminaire with emergency light self-contained supply:

elektrischer Anschluß:

Geschaltene Phase (L = L_s = L-~) und Dauerphase (L_{batt} = L_u = L—)

Electrical connection:

Switched phase (L = L_s = L-~) and continuous phase (L_{batt} = L_u = L—)

Batterieleitungen:

+ = positiv = rot
- = negativ = schwarz

Battery leads:

+ = positive = red
- = negative = black

Vor Inbetriebnahme:

Batterie anschließen und Batterie 24h laden, damit Notlichteinheit voll funktionsfähig. Inbetriebnahmedatum auf Batterie schreiben.

Before start-up:

Connect battery and charge battery for 24 hrs so that emergency light unit is fully functionable. Inscribe start-up date on battery.

Batteriewechsel:

Wird bei der Prüfung die Bemessungs-Betriebsdauer unterschritten (B3 = 3h - B1 = 1h), dann muss die Batterie gewechselt werden.

Battery replacement:

If during inspection the rated operating period is fallen short of (B3 = 3h - B1 = 1h) then the battery must be replaced.

Funktion LED:

"grün leuchten"
= Batterie wird geladen, Zustand System OK
"aus"
= Batterie wird nicht geladen, Störung

LED function:

'green lights up'
= battery is being charged, condition of system okay
'off'
= battery is not being charged, fault

Wartung/Test

Anforderungen nach EN 50172 beachten.

Maintenance/Test

Consider requirements of EN 50172.

Lagerung

optimale Lagerungsbedingungen sind:
-Temperatur: +5...+25°C
-relative Luftfeuchtigkeit: 65%±5%

Storage

ideal storage conditions are:
-Temperature: +5...+25°C
-relative humidity: 65%±5%

Externe Vorschaltung:

Die Verbindungsleitung zur Batterie ist separat zugentlastet. Die Batterie darf nicht auf der Vorschaltung liegen.

External connection:

The connection cable to the battery is separately strain relieved. The battery must not lie on the connection.

Abb.1



Feld/Field	Feld/Field	Feld/Field	Feld/Field
1	2	3	4

Aufkleber

"Einteilung der Notleuchten" nach
EN 60598-2-22:2020-12

Feld 1

X mit eingebauter Einzelbatterie
Z für zentrale Versorgung

Feld 2

**ist bei der Installation ggf. vom Elektriker
auszufüllen, siehe auch Anleitung**

0 Notleuchte in Bereitschaftsschaltung
1 Notleuchte in Dauerschaltung
2 Kombinierte Notleuchte in Bereitschaftsschaltung
3 Kombinierte Notleuchte in Dauerschaltung

Definitionen:

Notleuchte in Dauerschaltung:

Leuchte, bei der die Lampen für die Notbeleuchtung
immer dann ständig gespeist werden, wenn Allgemein-
beleuchtung oder Notbeleuchtung erforderlich ist.

Notleuchte in Bereitschaftsschaltung:

Leuchte, bei der die Lampen für die Notbeleuchtung
nur dann eingeschaltet sind, wenn die Stromversorgung
für die Allgemeinbeleuchtung ausfällt.

Kombinierte Notleuchte: .

Leuchte die zwei oder mehrer Lampen besitzt, von
denen mindestens eine von der Notlichtversorgung und
die andere(n) von dem Netz der Allgemeinbeleuchtung
gespeist wird (werden). Eine kombinierte Notleuchte
ist entweder für Dauerschaltung oder Bereitschaft-
schaltung ausgelegt.

Feld 3

A enthält eine Prüfeinrichtung
B enthält Fernschaltung für Ruhe-Zustand
C enthält Fernausschaltmöglichkeit
D Leuchte für Arbeitsstätten mit besonderer Gefährdung
E nicht austauschbarer(n) Lampe(n) und/oder Batterie
F Betriebsgerät mit automatischer Prüfeinrichtung
nach IEC 61347-2-7
G von innen beleuchtetes Sicherheitszeichen

Feld 4

*60 Betriebsdauer 1h
180 Betriebsdauer 3h
(nur für Leuchten mit eingebauter Einzelbatterie)
- sonst bleibt das Feld leer)

Label

'Classification of emergency luminaires' according
to EN 60598-2-22:2020-12

Field 1

X with integral single battery
Z for central supply

Field 2

**may be is to be filled out by the electrician,
see also instructions**

0 Emergency luminaire in stand-by operation
1 Emergency luminaire in maintained operation
2 Combined emergency luminaire in
stand-by operation
3 Combined emergency luminaire in
maintained operation

Definitions:

Emergency luminaire in maintained operation:

A luminaire with lamps for emergency lighting
permanently fed when general lighting or emergency
lighting is required.

Emergency luminaire in stand-by operation:

A luminaire with lamps for emergency lighting
only switched on when voltage supply for
general lighting fails.

Combined emergency luminaire:

A luminaire having two or more lamps from which at
least one is fed from the emergency light supply and the
other(s) are fed from the general lighting supply.
A combined emergency luminaire is designed either for
maintained operation or for stand-by operation.

Field 3

A Contains an inspection device
B Contains remote switching for idle state
C Contains possibility for remote switching off
D Luminaire for particularly hazardous workplaces
E non changeable lamps or batteries
F Ballast/Driver with autmatically inspection device
by IEC 61347-2-7
G inside illuminated safety sign

Field 4

*60 operation 1 hr
180 operation 3 hrs
(only for luminaires with integral single battery
- otherwise the field remains empty)

REGIOLUX

Regiolux GmbH
Hellinger Str. 3
D-97486 Königsberg/Bay.
T 09525 89-0
<http://www.regiolux.de>
info@regiolux.de

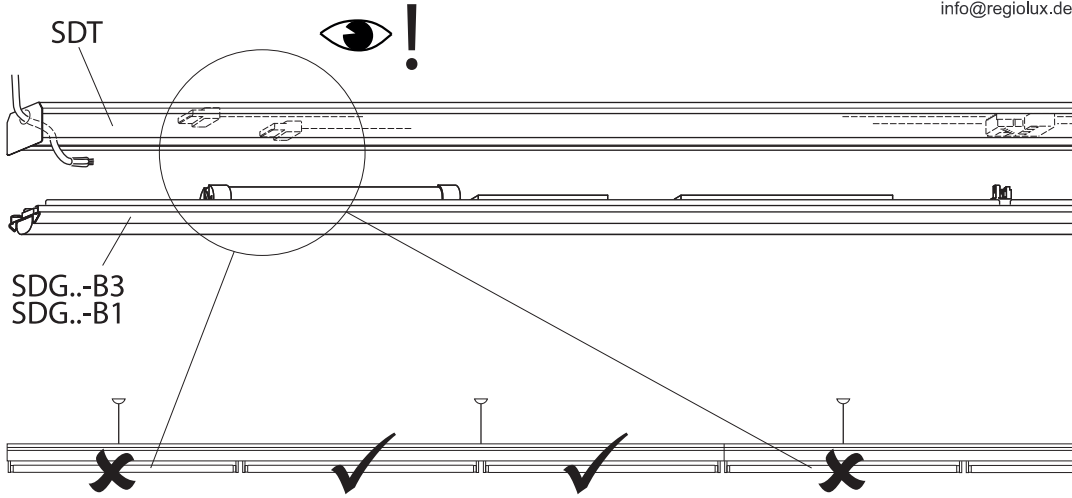

Art.-Nr. 531900 - 12/2014

REGIOLUX

Regiolux GmbH
Hellinger Str. 3
D-97486 Königsberg/Bay.
T 09525 89-0
<http://www.regiolux.de>
info@regiolux.de

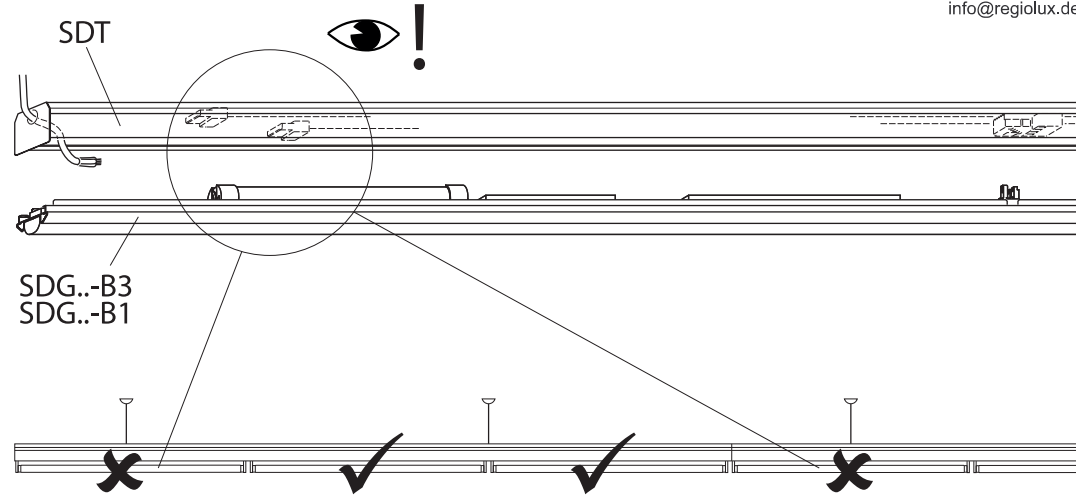

Art.-Nr. 531900 - 12/2014

REGIOLUX

Regiolux GmbH
Hellinger Str. 3
D-97486 Königsberg/Bay.
T 09525 89-0
<http://www.regiolux.de>
info@regiolux.de



Art.-Nr. 531900 - 12/2014

REGIOLUX

Regiolux GmbH
Hellinger Str. 3
D-97486 Königsberg/Bay.
T 09525 89-0
<http://www.regiolux.de>
info@regiolux.de



Art.-Nr. 531900 - 12/2014

INSTRUCTION

SDGMVO . B3

SDGMVOB

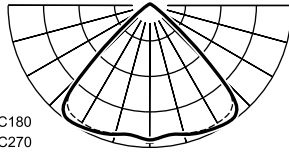

SDGMVOTB

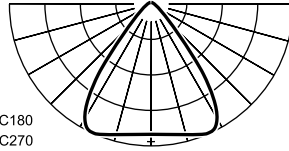

844 lm

Lichtstrom im Notlichtbetrieb

Luminous flux in emergency mode

Flux lumineux en mode d'urgence

Flujo luminoso en modo de emergencia

Art.-Nr.: 532010 - 01/21

REGIOLUX

Regiolux GmbH
Hellinger Str. 3
D-97486 Königsberg/Bay.
Telefon (0 95 25) 89-0
Telefax (0 95 25) 89 73 4
<http://www.regiolux.de>
e-Mail: info@regiolux.de

INSTRUCTION

SDGMVO . B3

SDGMVOB

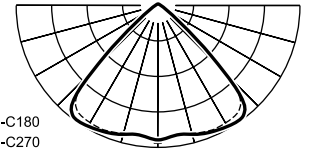

SDGMVOTB

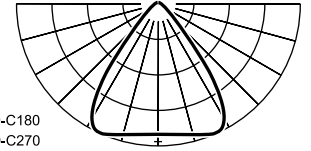

844 lm

Lichtstrom im Notlichtbetrieb

Luminous flux in emergency mode

Flux lumineux en mode d'urgence

Flujo luminoso en modo de emergencia

Art.-Nr.: 532010 - 01/21

REGIOLUX

Regiolux GmbH
Hellinger Str. 3
D-97486 Königsberg/Bay.
Telefon (0 95 25) 89-0
Telefax (0 95 25) 89 73 4
<http://www.regiolux.de>
e-Mail: info@regiolux.de

INSTRUCTION

SDGMVO . B3

SDGMVOB

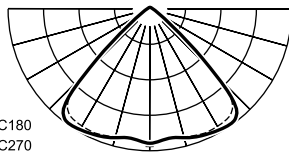

SDGMVOTB

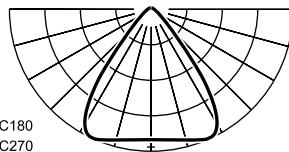

844 lm

Lichtstrom im Notlichtbetrieb

Luminous flux in emergency mode

Flux lumineux en mode d'urgence

Flujo luminoso en modo de emergencia

Art.-Nr.: 532010 - 01/21

REGIOLUX

Regiolux GmbH
Hellinger Str. 3
D-97486 Königsberg/Bay.
Telefon (0 95 25) 89-0
Telefax (0 95 25) 89 73 4
<http://www.regiolux.de>
e-Mail: info@regiolux.de

INSTRUCTION

SDGMVO . B3

SDGMVOB

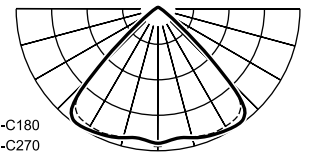

SDGMVOTB

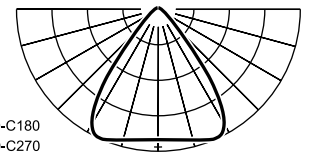

844 lm

Lichtstrom im Notlichtbetrieb

Luminous flux in emergency mode

Flux lumineux en mode d'urgence

Flujo luminoso en modo de emergencia

Art.-Nr.: 532010 - 01/21

REGIOLUX

Regiolux GmbH
Hellinger Str. 3
D-97486 Königsberg/Bay.
Telefon (0 95 25) 89-0
Telefax (0 95 25) 89 73 4
<http://www.regiolux.de>
e-Mail: info@regiolux.de

INSTRUCTION

SDGMVO .

Diese Leuchte enthält ein Leuchtmittel der Energieeffizienzklasse C

This luminaire contains a light source of energy efficiency class C

REGIOLUX

Regiolux GmbH
 Hellinger Str. 3
 D-97486 Königshausen/Bay.
 T 09525 89-0
 http://www.regiolux.de
 info@regiolux.de

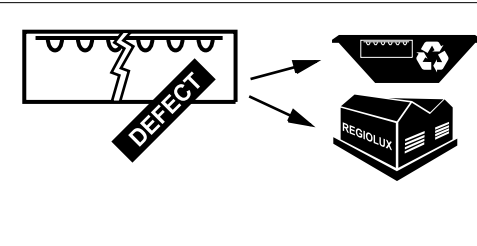
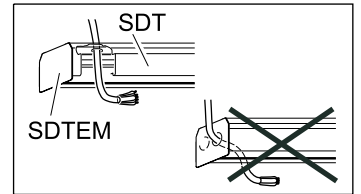
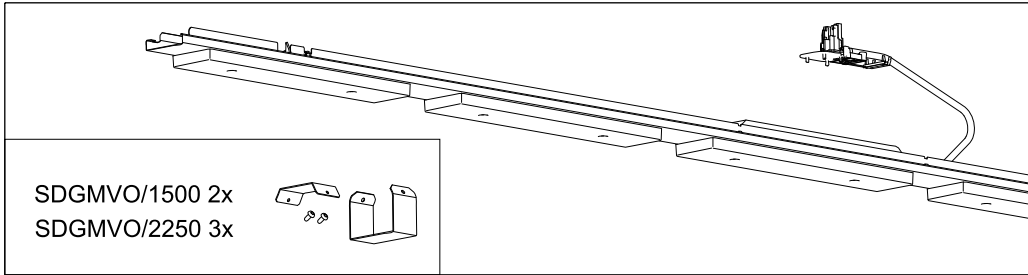

Achtung:
 Leuchte nicht öffnen!
 Garantieverlust!

Attention:
 Don't open the luminaire!
 Loss of Guarantee!

Attention:
 N'est pas ouvrir le luminaire,
 Perte de garantie!

Atención:
 Non abrir la luminara!
 Pérdida de garantía!

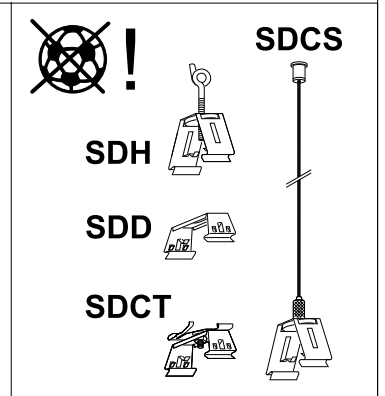
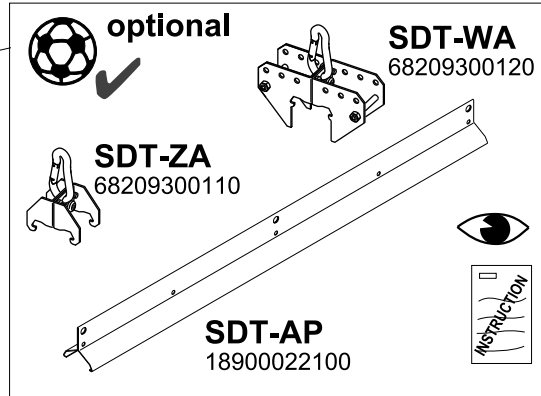
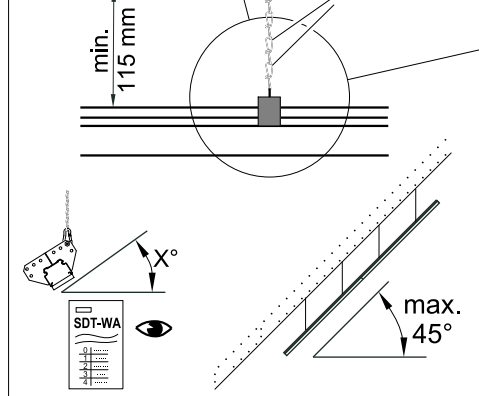
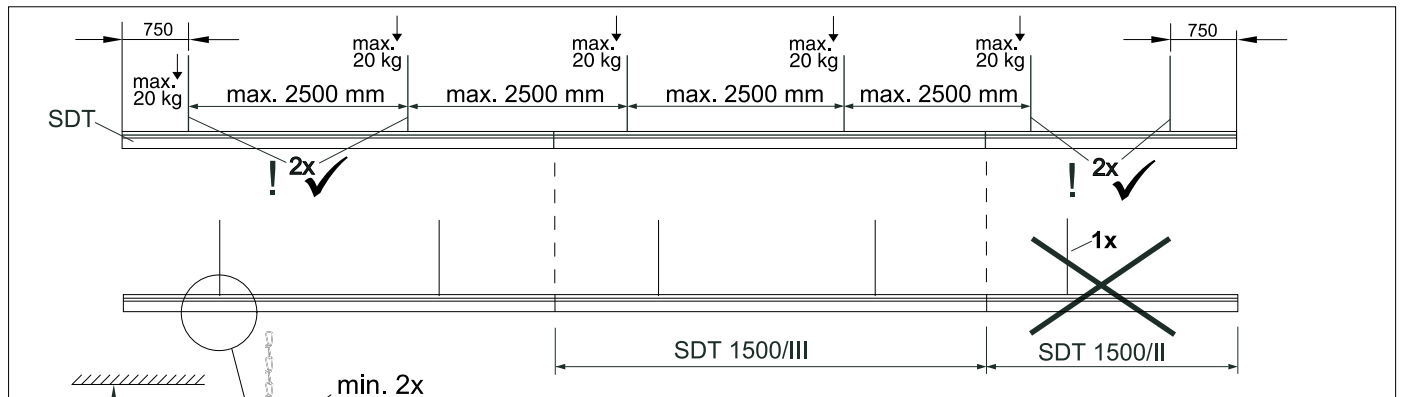
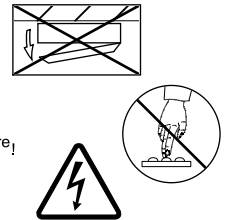

MONTAGE

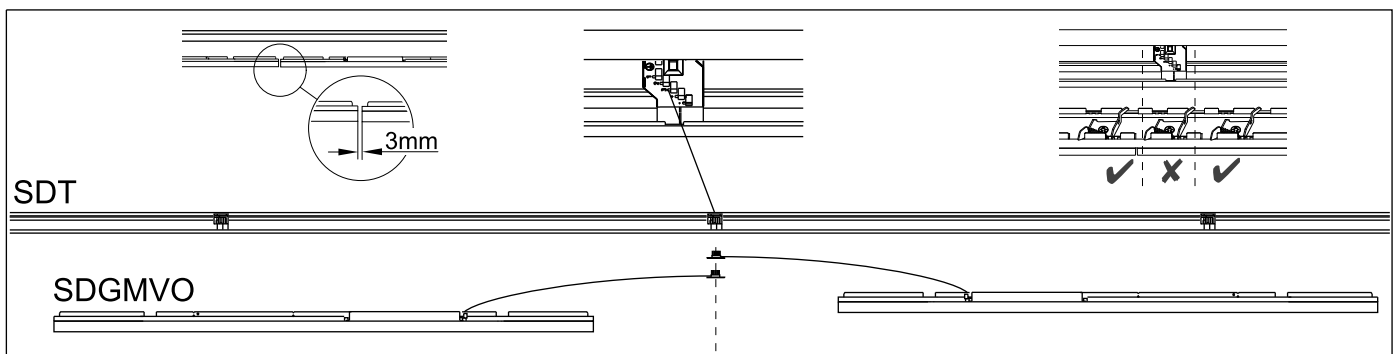
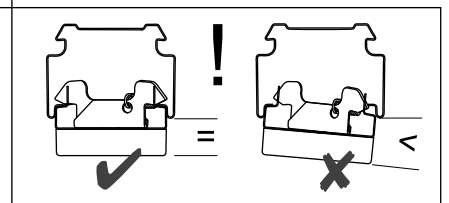
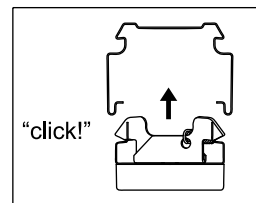
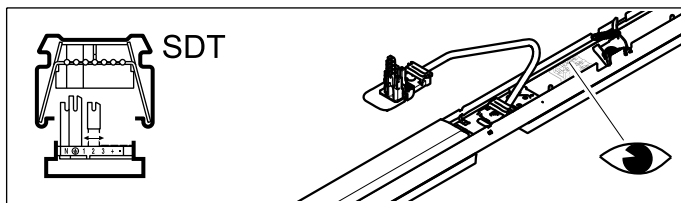

Art-Nr.: 532569 - 06/22



SDGMVO./2250



SDGMVO./1500

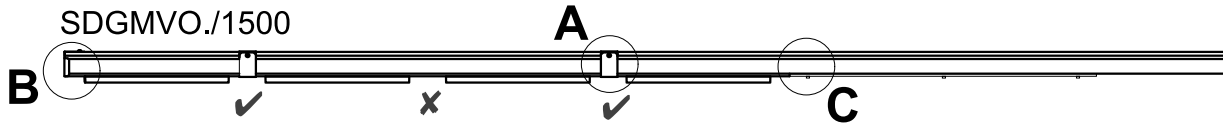

Torx
20

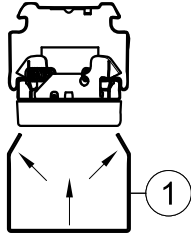

SDTEM
1890 0331 100

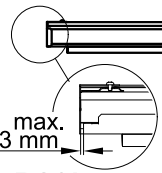
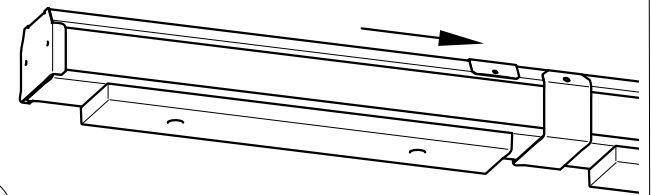
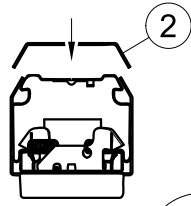
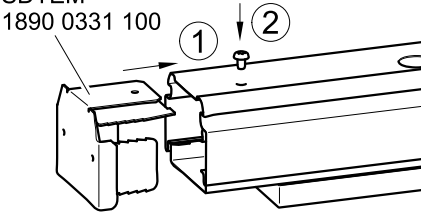

IP20!



SDTE

SDTES

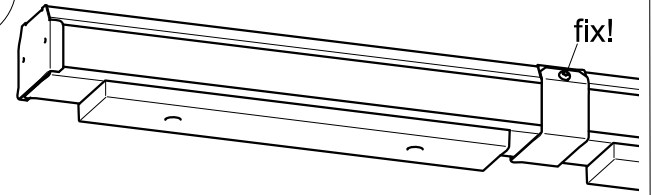
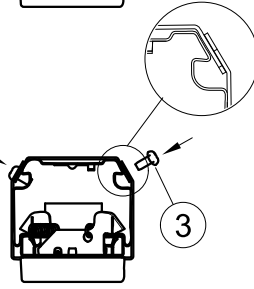

Option

SDBAV
18845580101

191,6

SDT + SDLA
18900058100
min 1,5 Nm
max 2,0 Nm



SDBK

SDBA

SDBAS

SDBKS

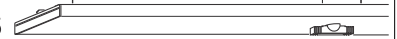
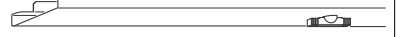
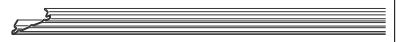
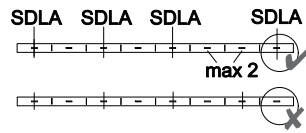
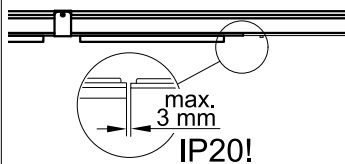

DEMONTAGE

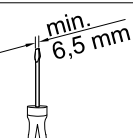
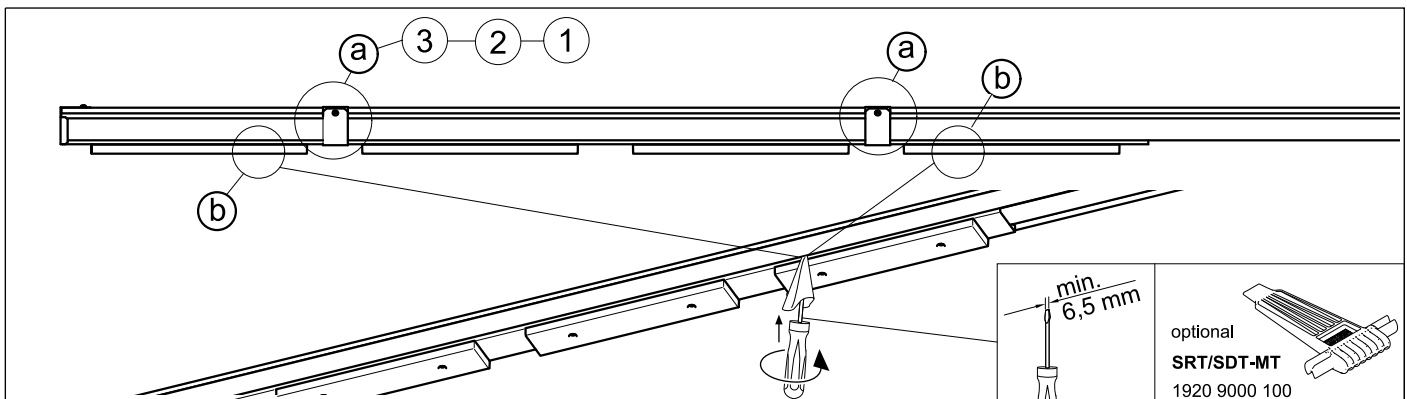

optional
SRT/SDT-MT
1920 9000 100

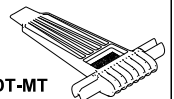

LED



Sicherheitshinweise

(D)



Safety Information

(GB)



Consignes de sécurité

(F)



Allgemeine Sicherheitshinweise

- Montage, Inbetriebnahme und Wartung nur durch Elektrofachkraft.
- Arbeiten Sie nie bei anliegender Spannung an der Leuchte. Lebensgefahr durch Stromschlag!
- Elektrischer Anschluss muss ordnungsgemäß, entsprechend allen geltenden Normen und sonstigen nationalen und internationalen Sicherheits- und Unfallverhütungsvorschriften erfolgen.
- Beschädigte Leuchten dürfen nicht betrieben werden.
- Sicherheitshinweise und Montageanleitung beachten und aufbewahren
- Keine Haftung für Schäden durch unsachgemäßen Einsatz.
- Bei Instandsetzung nur Originalteile verwenden.
- Tragfähigkeit der Decke und Befestigungselemente sicherstellen.
- Leuchte ausschließlich für Innenraumeinsatz und Umgebungstemperaturen bis 25°C geeignet, sofern mittels Etikettierung der Leuchte nicht anders beschrieben.



Betrieb der Leuchte

- Ungewöhnliche Dunkelstellen können auf Teilausfall von LED hinweisen. Regelmäßig prüfen und betroffene Leuchten austauschen. Die Lichtquelle (LED) dieser Leuchte darf nicht durch den Anwender ausgetauscht oder ersetzt werden.
- Eine Überschreitung der zulässigen Umgebungstemperatur reduziert die Lebensdauer der Leuchte, im Extremfall droht Frühausfall.
- Die Betauung der Leuchte ist zu vermeiden.
- Jegliche mechanische Belastung der LED Platinen ist unzulässig.
- LED können durch elektrostatische Entladung (ESD) geschädigt werden, bis hin zum Totalausfall. Direkte Berührung ist stets zu vermeiden.
- In Abhängigkeit von deren Konzentration können Chemikalien die LED-Module angreifen und zu Lichtstromreduktion, Drift der Lichtfarbe bzw. Totalausfall führen. Direkter Kontakt mit Säuren, Laugen, Lösemitteln, flüchtigen organischen Verbindungen bzw. Ölen ist stets zu vermeiden. Um Schäden durch Ausgasungen zu vermeiden, ist eine ausreichende Be- und Entlüftung zu gewährleisten.
- Zur Vermeidung von EMV-Problemen Durchgangsverdrahtung nicht unmittelbar entlang der Leuchtenverdrahtung führen.
- Steuereingänge von dimmbaren Leuchten mit handelsüblichen für Netzspannung geeigneten Leitungen anschließen.



Änderungen unserer Produkte

Veränderung, Umarbeitung, Umkenzeichnung von Produkten können deren technische Eigenschaften negativ beeinflussen, diese zerstören und möglicherweise Folgeschäden an anderen Objekten verursachen. Für durch derartige Änderungen verursachte Schäden kann der Hersteller nicht verantwortlich gemacht werden.

- ▽ + IP5x - nicht leitfähiger Staub
- ▽ + IP6x - leitfähiger und nicht leitfähiger Staub



General Safety Information

- Installation, commissioning and maintenance only by qualified electrician.
- Never perform any work on the luminaire with voltage applied. Danger to life due to electric shock!
- Electric connection must be appropriate according to all applicable standards and other national and international safety and accident prevention regulations.
- Damaged luminaires must not be operated.
- Observe and retain safety instructions and mounting instructions
- No liability is accepted for damages resulting from improper use.
- Use genuine parts only for repair.
- Ensure stability of the ceiling and fastening elements.
- The luminaire is exclusively intended for interior rooms and ambient temperatures not exceeding 25°C, unless otherwise described by labeling the luminaire.



Operation of the luminaire

- Abnormal dark spots may be an indication of partial failure of LEDs. Inspect regularly and replace the luminaires affected. The light source (LED) of this luminaire must not be exchanged or replaced by the user.
- Exceeding the permissible ambient temperature will reduce the luminaire's lifecycle, resulting in premature failure in extreme cases.
- Avoid condensation of the luminaire.
- Any mechanical load to the LED circuit boards is not permitted.
- LEDs can be damaged by electrostatic discharge (ESD). This may result in total failure. Always avoid direct contact.
- Depending on their concentration, chemicals can corrode the LED modules and lead to reduction of luminous flux, drift of luminous colour and/or total failure. Always avoid direct contact with acids, bases, solvents, volatile organic compounds and/or oils. Ensure sufficient ventilation to prevent damage by gas release.
- Avoid ESD problems by not routing feed-through wiring directly along the wiring of the luminaire.
- Connect control inputs of dimmable luminaires with standard cables suitable for power supply voltage.



Changes to our products

Modification, reworking, re-marking of products can have a negative impact on their technical properties, destroy them and possibly cause consequential damage to other objects. The manufacturer cannot be held responsible for damage caused by such changes.

- ▽ + IP5x - dust nonconductive
- ▽ + IP6x - dust conductive and dust nonconductive



Consignes générales de sécurité

- Montage, mise en service et maintenance uniquement par un électricien spécialisé.
- Ne travaillez jamais sur un luminaire sous tension. Danger de mort par choc électrique !
- Le branchement électrique doit être réalisé de manière correcte et conforme à toutes les normes en vigueur et autres prescriptions nationales et internationales relatives à la sécurité et à la prévention des accidents.
- Ne pas faire fonctionner de luminaires défectueux.
- Respecter et conserver les consignes de sécurité et les instructions de montage
- Nous déclinons toute responsabilité en cas de dommages dus à une utilisation incorrecte.
- Utiliser uniquement des pièces d'origine pour la réparation.
- Veiller à ce que la capacité portante du plafond et des éléments de fixation soit suffisante.
- Sauf indication contraire indiquée sur l'étiquette du luminaire, luminaire conçu uniquement pour une utilisation en intérieur et une température ambiante maximale de 25 °C.



Fonctionnement du luminaire

- Des zones d'ombre inhabituelles peuvent indiquer un défaut partiel des LED. Contrôler régulièrement et remplacer les luminaires concernés. Utilisateur n'est pas autorisé à échanger ou à remplacer la source de lumière (LED) de ce luminaire.
- Le dépassement des températures ambiantes admissibles réduit la longévité du luminaire; dans les cas extrêmes, cela peut entraîner des pannes prématurées.
- Éviter toute condensation sur le luminaire.
- Ne jamais soumettre les platines à LED à des charges mécaniques.
- Les décharges électrostatiques (DES) peuvent endommager les LED et entraîner leur destruction totale. Toujours éviter le contact direct.
- En fonction de leur concentration, les produits chimiques peuvent attaquer les modules à LED et entraîner une baisse du flux lumineux, une dérive de la température de couleur voire une panne totale. Toujours éviter le contact direct avec les acides, les lessives alcalines, les solvants, les composés et huiles organiques volatils. Assurer une ventilation et une aération suffisantes pour éviter les dégâts dus aux dégagements de gaz.
- Pour éviter les problèmes de CEM, ne pas poser le câblage de liaison directement à côté du câblage du luminaire.
- Brancher les entrées de commande des luminaires à gradation à l'aide de câbles standard adaptés à la tension secteur.



Modification de nos produits

La modification, la transformation et la modification de marquage des produits peuvent avoir une influence négative sur leurs propriétés techniques, détériorer les produits et causer des dommages indirects sur d'autres objets. Le fabricant ne saurait être tenu responsable des dommages causés par ces modifications.

- ▽ + IP5x - non conductrice de la poussière
- ▽ + IP6x - poussière conductrice et de la poussière non conductrice

Information für Wartung, Reinigung und Entsorgung von LED-Leuchten Information for service, cleaning and disposal of luminaire

Instruktion für Wartung von Leuchten: Instruction for luminaire service:

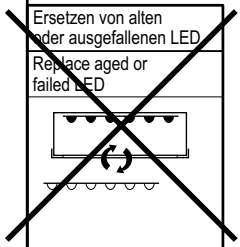

Instruktion für Ende der Lebensdauer: Instruction for end of life:

Ausschalten, Stromzufuhr zur Leuchte unterbrechen
Switch off, switch off supply to luminaire

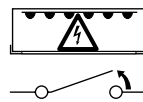

Batterie entfernen zur Entsorgung
Remove battery for disposal

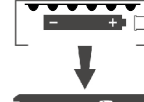

Leuchte entfernen zur Entsorgung
Remove luminaire for disposal

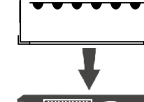

Das Material an WEEE Entsorgungsstelle liefern
Dispatch materials to WEEE recycling plant



Instruktion für Reinigung von Leuchten: Instruction for luminaire cleaning

Leuchte reinigen
Clean luminaire

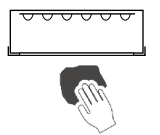

Ausschalten, Stromzufuhr zur Leuchte unterbrechen
Switch off, switch off supply to luminaire

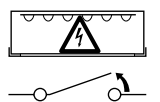

Leuchte außen reinigen
Clean outside luminaire

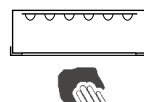

Optik entfernen
Remove optic

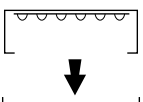

Nur bei SELV! Only SELV!
Leuchte innen reinigen
Clean inside luminaire



Optik wieder anbringen
Refit optic

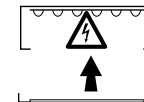

Funktionstest durchführen
Make functional test

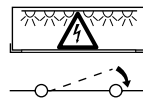

**Advertencias de seguridad**

E

**Avvertenze sulla sicurezza**

I

**Zasady bezpieczeństwa**

PL

**Advertencias de seguridad generales**

- El montaje, la puesta en funcionamiento y el mantenimiento deberán ser realizados exclusivamente por electricistas profesionales.
- No realice nunca trabajos en la luminaria cuando esta esté sometida a tensión. ¡Peligro de muerte por descarga eléctrica!
- La conexión eléctrica se debe realizar de modo reglamentario, de conformidad con todas las normas vigentes y con las demás prescripciones nacionales e internacionales de seguridad y prevención de accidentes.
- Tenga en cuenta las advertencias de seguridad y las instrucciones de montaje y conserve los documentos correspondientes como referencia.
- No se asume ninguna responsabilidad por daños debidos a un uso antirreglamentario.
- Al hacer reparaciones, utilice exclusivamente piezas originales.
- Asegúrese de que el techo y los elementos de fijación tengan la capacidad de carga suficiente.
- A menos que se describa lo contrario etiquetando la luminaria, la luminaria es apta exclusivamente para su uso en interiores y a una temperatura ambiente de hasta 25 °C.

**Funcionamiento de la luminaria**

- La aparición de puntos oscuros inusuales puede ser indicio de la avería de algunos ledes. Realice revisiones periódicas y sustituya las luminarias defectuosas.
- El rebase de la temperatura ambiente permitida conlleva una reducción de la vida útil de la luminaria y, en casos extremos, el riesgo de una avería prematura.
- Se debe evitar la condensación en la luminaria.
- Está prohibida toda carga mecánica sobre las pletinas de los ledes.
- Una descarga electrostática podría provocar daños en los ledes e incluso una avería total. Se deberá evitar siempre el contacto directo con estos.
- Según su grado de concentración, los productos químicos pueden atacar los módulos de ledes y provocar una reducción del flujo luminoso, alteraciones en el tono de la luz o una avería total. Se debe evitar bajo cualquier circunstancia el contacto directo con ácidos, lejías, disolventes, compuestos orgánicos volátiles o aceites. Para evitar daños debidos a las emisiones de gas, es necesario garantizar una ventilación suficiente de entrada y salida.
- Para evitar problemas de compatibilidad electromagnética, no tienda los cables de paso junto a los cables de la luminaria.
- Conecte las entradas de mando de luminarias atenuables mediante cables convencionales adecuados para tensión de red.

Modificaciones de nuestros productos

La modificación, la reelaboración y el remarcado de los productos pueden influir negativamente en sus propiedades técnicas, destruirlos y, posiblemente, causar los consiguientes daños a otros objetos. El fabricante no se hace responsable de los daños causados por dichas modificaciones.

▽+ IP5x - polvo no conductor

▽+ IP6x - polvo conductor y no conductor

**Avvertenze generali sulla sicurezza**

- Il montaggio, l'impiego e la manutenzione devono essere eseguiti solo da un elettricista specializzato.
- Non lavorare mai sulla lampada con tensione elettrica inserita. Pericolo di morte a causa di scossa elettrica!
- L'allacciamento elettrico deve essere eseguito a regola d'arte, in conformità a tutte le norme vigenti, alle disposizioni nazionali e internazionali di sicurezza e alle normative antinfortunistiche.
- Le lampade danneggiate non devono essere utilizzate ulteriormente.
- Osservare e conservare le avvertenze di sicurezza e le istruzioni di montaggio.
- Non lavorare mai sulla lampada con tensione elettrica inserita.
- Per le riparazioni utilizzare solo parti di ricambio originali.
- Verificare la portata del soffitto e degli elementi di fissaggio.
- La lampada è prevista solo per uso interno e temperature ambiente fino a 25 °C, se non diversamente descritto dall'etichettatura dell'apparecchio.

**Funzionamento della lampada**

- Punti scuri insoliti possono indicare un guasto parziale dei LED. Controllare regolarmente e sostituire le lampade in questione.
- Il superamento della temperatura ambiente consentita riduce la durata utile della lampada, in casi estremi si rischia un guasto precoce.
- Evitare la condensazione della lampada.
- È vietata qualsiasi sollecitazione meccanica delle schede LED.
- I LED possono essere danneggiati dalle scariche elettrostatiche (ESD), con possibilità di guasto totale. Si deve sempre evitare il contatto diretto.
- In rapporto alla loro concentrazione, le sostanze chimiche possono aggredire i moduli LED provocando la riduzione del flusso luminoso, la deriva del colore della luce o un guasto totale. Si deve sempre evitare il contatto diretto con acidi, basi, solventi, composti organici volatili o oli. Per evitare danni da emissioni di gas, si deve garantire una sufficiente ventilazione e disaerazione.
- Per evitare problemi di CEM, il cablaggio di transito non deve essere posato direttamente insieme al cablaggio della lampada.
- Collegare gli ingressi di comando delle lampade dimmerabili (varialuce) usando dei cavi adeguati per la tensione di rete.

Modificaciones de nuestros productos

Modifiche, conversioni, cambi dell'etichettatura apportati ai prodotti possono influenzare negativamente le loro proprietà tecniche, distruggerli ed eventualmente causare danni ad altri oggetti. Il produttore non può essere ritenuto responsabile di eventuali danni causati da tali modifiche.

▽+ IP5x - polvere non conduttiva

▽+ IP6x - polvere conduttiva e non conduttiva

**Ogólne zasady bezpieczeństwa**

- Prace związane z montażem, uruchomieniem i konserwacją mogą wykonywać tylko elektrycy.
- Nigdy nie wykonywać prac przy oprawie, gdy znajduje się ona pod napięciem. Niebezpieczeństwo dla życia z powodu porażenia prądem!
- Przyłącze elektryczne musi być wykonane profesjonalnie, zgodnie ze wszystkimi obowiązującymi normami oraz innymi krajowymi i międzynarodowymi przepisami bezpieczeństwa i zapobiegania wypadkom.
- Przestrzegać zasad bezpieczeństwa i wytycznych instrukcji montażu oraz zachować je do późniejszego użytku.
- Producent nie ponosi odpowiedzialności za nieprawidłowe stosowanie.
- W przypadku naprawy używać tylko oryginalnych części.
- Zapewnić nośność sufitu i elementów mocujących.
- Oprawa przeznaczona jest wyłącznie do stosowania w pomieszczeniach w temperaturach otoczenia do 25 °C, o ile nie opisano inaczej, oznaczając oprawę.

**Eksplatacja oprawy**

- Nietypowe zaciemnione miejsca mogą wskazywać na częściową awarię oprawy LED. Należy regularnie dokonywać kontroli i wymieniać uszkodzone oprawy.
- Przekroczenie dopuszczalnej temperatury otoczenia skracza trwałość oprawy, w skrajnym przypadku grozi przedwczesną awarią.
- Unikać obroszenia oprawy.
- Niedopuszczalne jest jakiegokolwiek obciążenie mechaniczne płytek LED.
- Diody LED mogą ulec uszkodzeniu wskutek wyładowania elektrostatycznego (ESD), a nawet ulec całkowitej awarii. Zawsze należy unikać bezpośredniego kontaktu.
- W zależności od stężenia chemikalia mogą uszkodzić moduły LED i prowadzić do obniżenia strumienia światła, zmiany barwy światła lub całkowitej awarii. Zawsze należy unikać bezpośredniego kontaktu z kwasami, ługami, rozpuszczalnikami, lotnymi związkami organicznymi lub olejami. Celem uniknięcia szkód z powodu emisji gazów należy zapewnić odpowiednią wentylację i odpowietrzanie.
- Aby uniknąć problemów EMC, nie prowadzić okablowania przelotowego bezpośrednio wzdłuż okablowania oprawy.
- Wejścia sterujące opraw z funkcją ściemniania podłączać za pomocą dostępnych powszechnie w sprzedaży przewodów odpowiednich od napięcia sieciowego.

Zmiany naszych produktów

Zmiany, przeróbki, modyfikacja oznaczeń produktów mogą mieć negatywny wpływ na ich parametry techniczne, spowodować ich awarię, a także być możliwą przyczyną powstania szkód następujących w innych obiektach. Producent nie odpowiada za szkody spowodowane tego typu modyfikacjami.

▽+ IP5x - pył nieprzewodzący

▽+ IP6x - pył przewodzący i nieprzewodzący



Инструкциите за безопасност на вашия национален език можете да намерите Интернет.



Sikkerhedsinstruktionerne på dit lands sprog findes på Internettet.



Riikliku keele ohutusjuhiseid leiab Internetist.



Sigurnosne upute na vašem nacionalnom jeziku mogu se naći na Internetu.



Drošības norādījumus savā valsts valodā var atrast internetā.



Saugos nurodymus savo valstybine kalba galima rasti internete.



Sikkerhetsinstruksjonene på ditt nasjonalspråk finnes på Internett.



As instruções de segurança em sua língua nacional podem ser encontradas na Internet.



Instrucțiunile de siguranță din limba dvs. națională pot fi găsite pe Internet.



Säkerhetsanvisningarna på ditt nationella språk finns på Internet.



Bezpečnostné pokyny vo vašom národnom jazyku nájdete na internetovej.



Varnostna navodila v vašem nacionalnem jeziku so na voljo na spletni strani.



Bezpečnostní pokyny ve vašem národním jazyce naleznete na internetu.



Ulusal dilinizdeki güvenlik talimatları internette.



A nemzeti nyelvű biztonsági utasítások megtalálhatók az interneten.



Οι οδηγίες ασφάλειας στην εθνική σας γλώσσα διατίθενται στο διαδίκτυο.