

INSTRUCTION

turas easy41

2190

REGIOLUX

Regiolux GmbH
 Hellinger Str. 3
 D-97486 Königshausen/Bay.
 Telefon (0 95 25) 89-0
 Telefax (0 95 25) 89 73 4
 http://www.regiolux.de
 e-Mail: info@regiolux.de

Diese Leuchte enthält ein Leuchtmittel der Energieeffizienzklasse C

This luminaire contains a light source of energy efficiency class C

TUARO /380 /500

TUAQO /400



easy41

DIP-Schaltereinstellungen / DIP Switch Settings



- 1 Erfassungsbereich / Detection Range
- 2 Haltezeit / Hold Time
- 3 Tageslichtschwelle / Daylight Threshold

| 1 | 1 | 2 | 3 | |
|-----|---|---|---|------|
| I | ● | ○ | ○ | 100% |
| II | ○ | ○ | ○ | 75% |
| III | ○ | ○ | ○ | 50% |
| IV | ○ | ○ | ○ | 20% |
| V | ○ | ○ | ○ | 10% |



- I - 100%
- II - 75%
- III - 50%
- IV - 25%
- V - 10%

| 2 | 1 | 2 | 3 | 4 | |
|-----|---|---|---|---|--------|
| I | ● | ○ | ○ | ○ | 30 min |
| II | ○ | ○ | ○ | ○ | 20 min |
| III | ○ | ○ | ○ | ○ | 6 min |
| IV | ○ | ○ | ○ | ○ | 90 s |
| V | ○ | ○ | ○ | ○ | 30 s |
| VI | ○ | ○ | ○ | ○ | 10 s |



- I - 30 min
- II - 20 min
- III - 6 min
- IV - 90s
- V - 30s
- VI - 10s

| 3 | 1 | 2 | 3 | 4 | |
|-----|---|---|---|---|--------|
| I | ○ | ○ | ○ | ○ | 50 Lux |
| II | ○ | ○ | ○ | ○ | 30 Lux |
| III | ○ | ○ | ○ | ○ | 10 Lux |
| IV | ○ | ○ | ○ | ○ | 5 Lux |



- I - Disabled
- II - 50 Lux
- III - 30 Lux
- IV - 10 Lux
- V - 5 Lux

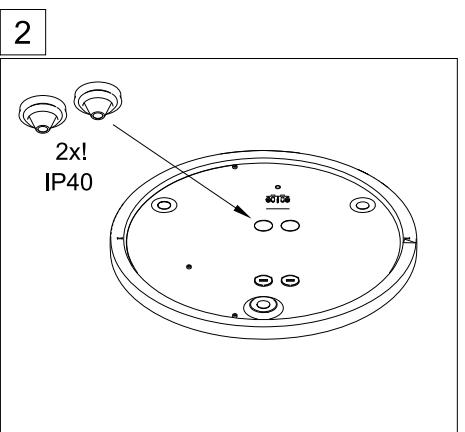
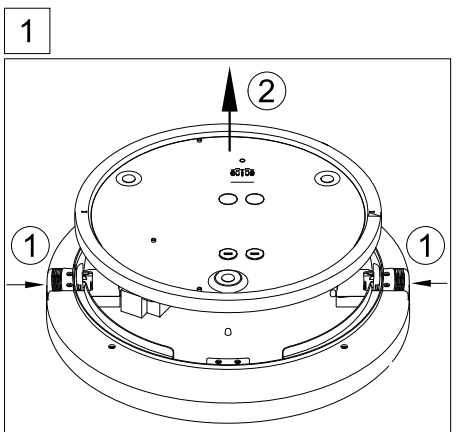
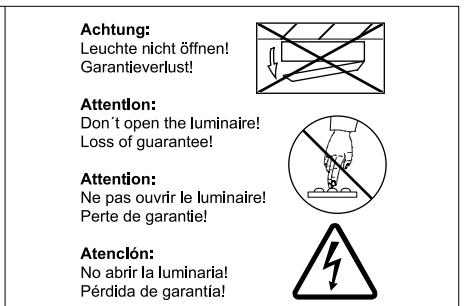
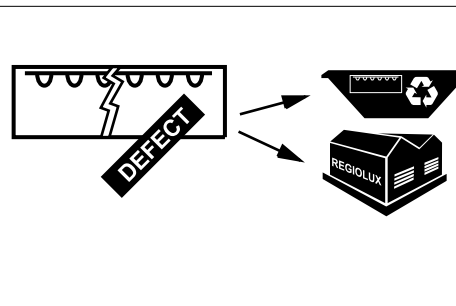



Demontage



Erfassungsbereich

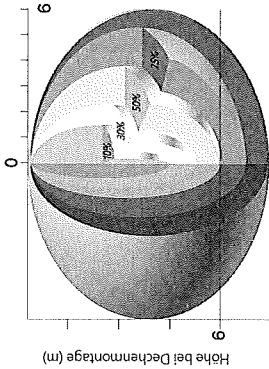

Höhe bei Wandmontage (m)

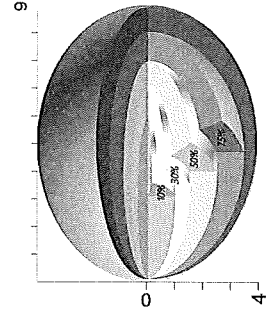

Deckenmontage (m)

Wandmontage (m)

Ein/Aus HF Sensor

HC009S-KD
mit abgesetzter Antenne

Anwendung:

Bewegungsmelder mit Ein/Aus Steuerung.
Geeignet für die Verwendung in Innenräumen und den Einbau in Leuchten.

- Büro/Gewerbebeleuchtungen
- Besprechungsräumen
- Klassenzimmer

Verwendung für moderne Leuchtendesigns und Installationen.

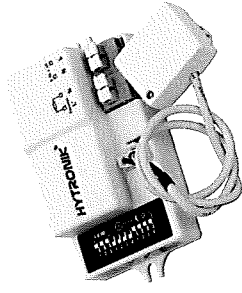

HYTRONIK®

Eigenschaften

- Einschaltstrom wird minimiert um die Lebensdauer des Relais zu erhöhen
- Loop-in und loop-out für eine einfache Installation
- 5 Jahre, 50.000 Stunden Garantie

Technische Daten

Netz-Eigenschaften

| Produkttyp | HC009S-KD |
|---------------------------|---------------------------------------|
| Netzspannung | 220-240VAC 50/60Hz |
| Stand-by Leistung: | <0.5W |
| Kapazitive Last | 800VA |
| Ohmsche Last | 1400W |
| Startzeit | 20s |
| Sicherheit und EMC Normen | EN55015, EN61000 |
| EMC Normen | EN300440, EN301489, EN301489, EN62479 |
| Sicherheitsnormen (LVD) | EN60669-2-1, AS/NZS60669 |
| Radio Equipment (RED) | SemiCo, CB, CE, EMC, RED, SAA |
| Zertifizierung | |

Sensor Daten

| Produkttyp | HC009S-KD |
|--------------------------|-------------------------|
| Sensor Art | HF Sensor |
| Betriebsfrequenz | 5.8GHz +/- 75MHz |
| Sendeleistung | <0.2mW |
| Erfassungsbereich | Max. (Ø x H) 12m x 6m |
| Erfassungswinkel | 30° ~ 150° |
| Einstellungen: | |
| Sensibilität | 10%/25%/50%/75%/100% |
| Haltezeit | 10s ~ 30min (wählbar) |
| Tageslichtwert | 5 ~ 50 lux, deaktiviert |
| Betriebsdaten | |
| Umgebungstemperatur | Ta: -35°C ~ +70°C |
| Gehäusetemperatur (Max.) | Tc: +80°C |
| IP Schutzart | IP20 |

CE RED SAA CB IP20

| | 1 | 2 | 3 | 4 |
|-----|---|---|---|---|
| I | ● | ● | ● | ● |
| II | ○ | ○ | ○ | ○ |
| III | ○ | ○ | ○ | ○ |
| IV | ○ | ○ | ○ | ○ |
| V | ○ | ○ | ○ | ○ |

- I – 100%
- II – 75%
- III – 50%
- IV – 25%
- V – 10%

| | 1 | 2 | 3 | 4 |
|-----|---|---|---|---|
| I | ● | ● | ● | ● |
| II | ○ | ○ | ○ | ○ |
| III | ○ | ○ | ○ | ○ |
| IV | ○ | ○ | ○ | ○ |
| V | ○ | ○ | ○ | ○ |
| VI | ○ | ○ | ○ | ○ |

- I – 30 min
- II – 20 min
- III – 6 min
- IV – 90s
- V – 30s
- VI – 10s

| | 1 | 2 | 3 | 4 |
|-----|---|---|---|---|
| I | ● | ● | ● | ● |
| II | ○ | ○ | ○ | ○ |
| III | ○ | ○ | ○ | ○ |
| IV | ○ | ○ | ○ | ○ |
| V | ○ | ○ | ○ | ○ |

- I – Disabled
- II – 50 Lux
- III – 30 Lux
- IV – 10 Lux
- V – 5 Lux

Erfassungsbereich

Der Erfassungsbereich kann durch Auswahl der Kombination mit den DIP-Schaltern eingegrenzt werden. Schalter passend für jede spezifische Anwendung.

Haltezeit

Nach Erfassung einer Bewegung kann mit der DIP-Schalterkonfiguration die Einschaltdauer gewählt werden. Diese Funktion ist deaktiviert, wenn Tageslicht ausreicht.

Tageslichtwert

Stellen Sie das Level entsprechend der Einrichtung und der Umgebung ein. Die Leuchte schaltet sich nicht ein, wenn der Lux-Wert der Umgebung den voreingestellten Tageslicht-Grenzwert überschreitet.

Bitte beachten Sie, dass sich der Umgebungs-Lux-Wert auf das interne Licht bezieht, das den Sensor erreicht. Die Deaktivierung des Tageslichtsensors versetzt den Sensor in den Modus "Nur Anwesenheitserfassung".

Sensor Hauptkörper

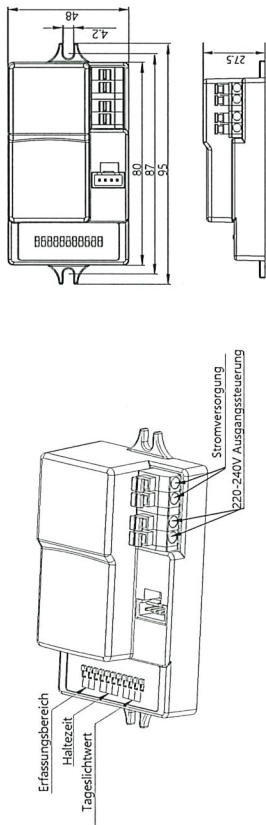

Abgesetzte Sensor Antennen Modul

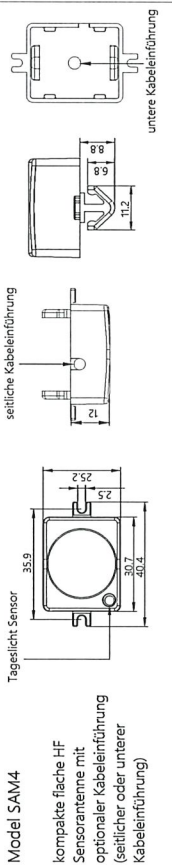

Typische Anwendungsbereiche:

Für Büroleuchten, die aus Aluminium bestehen und für HF Signale nicht durchlässig sind.

Für flache LED-Lampen

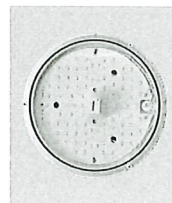

Bei solchen Anwendungen wird nur die abnehmbare kleine Antenne auf der Außenfläche benötigt, während der Sensorkörper und der Treiber/Vorschaltgerät hinter der Platte versteckt werden können.

Funktionen und Eigenschaften

Ein/Aus Steuerung

Dieser Sensor ist ein Bewegungsschalter, der bei Erkennung einer Bewegung das Licht einschaltet und nach einer vorgewählten Haltezeit wieder ausschaltet, wenn keine Bewegung stattfindet. Außerdem ist ein Tageslichtsensor eingebaut, der verhindert, dass das Licht bei ausreichendem Tageslicht eingeschaltet wird.

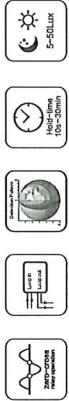
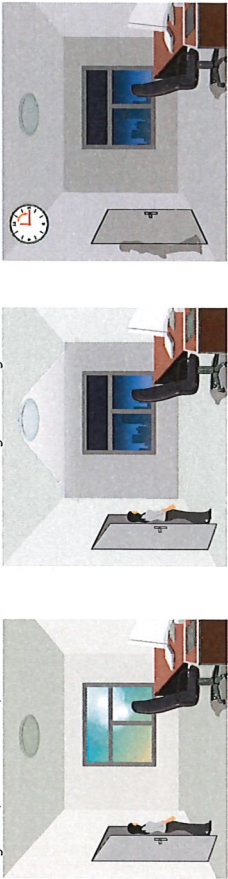

2 Nulldurchgangschaltung

Durch die intelligente Elektronik wird gewährleistet, dass die Last nahe dem Nulldurchgangspunkt geschaltet wird um den Einschaltstrom zu minimieren und die Lebensdauer des Relais zu erhöhen.

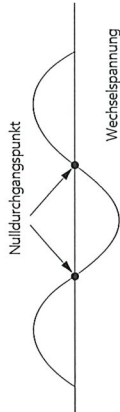

3 Loop-in und Loop-out Eingang

Durch den Loop-in und Loop-out Eingang (der doppelten L N-Klemme) sparen Sie sich Mehrkosten, sowie Zeit bei der Montage.

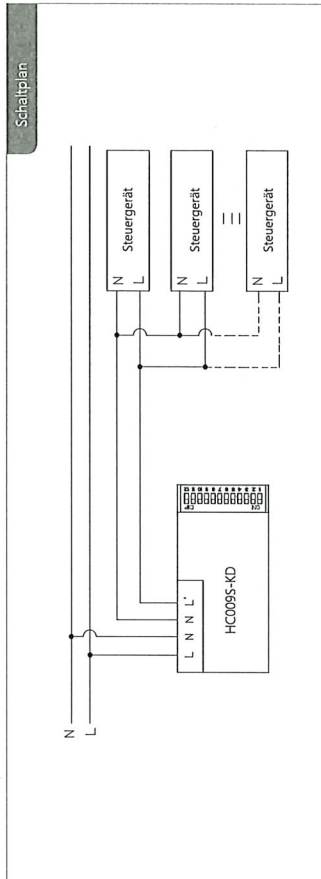

Detection Pattern

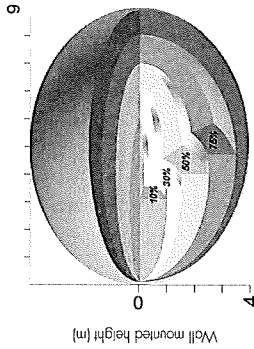

Ceiling mounted detection pattern (m)

Wall mounted detection pattern (m)

DIP Switch Settings

1 Detection Range

Sensor sensitivity can be adjusted by selecting the combination on the DIP switches to fit precisely for each specific application.

| | | | | |
|-----|---|---|---|---|
| | 1 | 2 | 3 | 4 |
| I | ● | ● | ● | ● |
| II | ○ | ○ | ○ | ○ |
| III | ○ | ○ | ○ | ○ |
| IV | ○ | ○ | ○ | ○ |
| V | ○ | ○ | ○ | ○ |

I – 100%
II – 75%
III – 50%
IV – 25%
V – 10%

2 Hold Time

Select the DIP switch configuration for the light on-time after presence detection. This function is disabled when natural light is sufficient.

| | | | | |
|-----|---|---|---|---|
| | 1 | 2 | 3 | 4 |
| I | ● | ● | ● | ● |
| II | ○ | ○ | ○ | ○ |
| III | ○ | ○ | ○ | ○ |
| IV | ○ | ○ | ○ | ○ |
| V | ○ | ○ | ○ | ○ |
| VI | ○ | ○ | ○ | ○ |

I – 30 min
II – 20 min
III – 6 min
IV – 90s
V – 30s
VI – 10s

3 Daylight Threshold

Set the level according to the fixture and environment. The light will not turn on if ambient lux level exceeds the daylight threshold preset.
Please note that the ambient lux level refers to internal light reaching the sensor.

| | | | | |
|-----|---|---|---|---|
| | 1 | 2 | 3 | 4 |
| I | ● | ● | ● | ● |
| II | ○ | ○ | ○ | ○ |
| III | ○ | ○ | ○ | ○ |
| IV | ○ | ○ | ○ | ○ |
| V | ○ | ○ | ○ | ○ |

I – Disabled
II – 50 lux
III – 30 lux
IV – 10 lux
V – 5 lux

Disabling the daylight sensor will put the sensor into occupancy detection only mode.

On/off Control HF Sensor

HC009S-KD
Detached Version

Applications

Occupancy detector with on/off control suitable for indoor use.

Suitable for building into the fixture:

- Office / Commercial lighting
- Meeting room
- Classroom

Use for new luminaire designs and installations

Features

- ⚡ Zero crossing detection circuit reduces inrush current and prolongs relay life
- ⚙️ Loop-in and loop-out terminal for efficient installation
- 🕒 5 Year, 50,000hr Warranty

Technical Data

Input Characteristics

| Model No. | HC009S-KD |
|-----------------------|--|
| Mains voltage | 220-240VAC 50/60Hz |
| Stand-by power | <0.5W |
| Load ratings: | |
| Capacitive | 800W |
| Resistive | 1400W |
| Warming-up | 20s |
| Safety and EMC | |
| EMC standard [EMC] | EN55015, EN61000 |
| Safety standard [LVD] | EN60669-2-1, AS/NZS60669 |
| Radio Equipment [RED] | EN300440, EN301489, EN301489, EN62479 |
| Certification | Semko, CB, CE, EMC, RED, SAA |

Sensor Data

| Model No. | HC009S-KD |
|-------------------------|------------------------------|
| Sensor principle | High Frequency (microwave) |
| Operation frequency | 5.8GHz +/- 75MHz |
| Transmission power | <0.2mW |
| Detection range | Max. (∅ x H) 12m x 6m |
| Detection angle | 30° ~ 150° |
| Setting adjustments: | |
| Sensitivity | 10% / 25% / 50% / 75% / 100% |
| Hold-time | 10s ~ 30min (selectable) |
| Daylight threshold | 5 ~ 50 lux, disable |
| Environment | |
| Operation temperature | Ta: -35°C ~ +70°C |
| Case temperature (Max.) | Tc: +80°C |
| IP rating | IP20 |

CE [EMC] RED [SAA] CB IP20

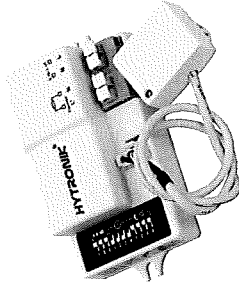

HYTRONIK®

Sensor Main body

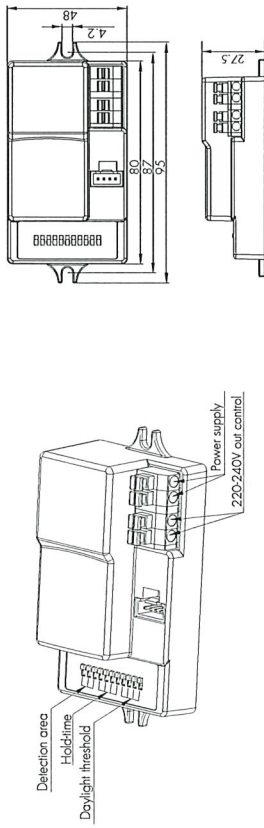

Detached Sensor Antenna Modul

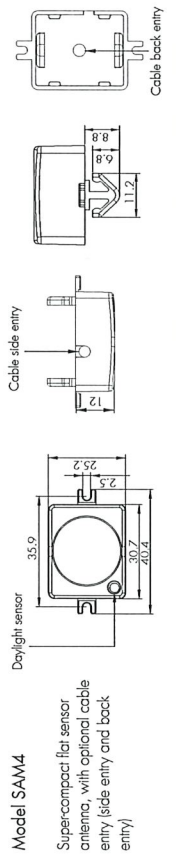

Typical applications:

Office light, most of which have aluminium loures and is impossible for microwave sensors to go through.

For LED bulkhead

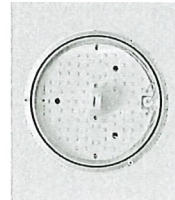

In such applications, only the detached small antenna is needed on the outer surface, while the sensor body and the driver/ballast can be hidden behind the panel. No shadow is cast in the shade.

Functions and Features

1 On/off Control

This sensor is a motion switch, which turns on the light upon detection of motion, and turns off after a pre-selected hold-time when there is no movement. A daylight sensor is also built in to prevent the light from switching on when there is sufficient natural light.



With sufficient natural light, the light does not switch on when presence is detected.

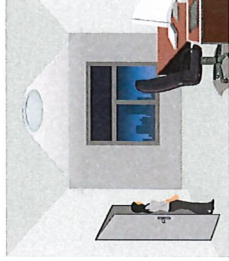

With insufficient natural light, the sensor switches on the light automatically when presence is detected.

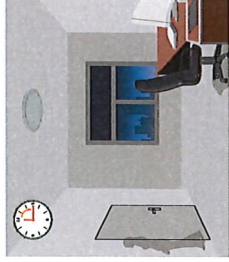

The sensor switches off the light automatically after the hold-time when there is no motion detected.

2 Zero-cross Relay Operation

Designed in the software, sensor switches on/off the load right at the zero-cross point, to ensure that the inrush current is minimised, enabling the maximum lifetime of the relay.

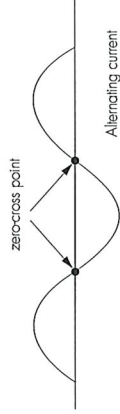

3 Loop-in and Loop-out Terminal

Double L N terminal makes it easy for wire loop-in and loop-out, and saves the cost of terminal block and assembly time.

Wiring Diagram

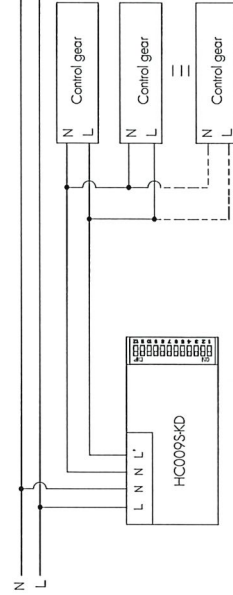



HYTRONIK

HYTRONIK INDUSTRIAL LIMITED
 Room D, 10/F, Tower A, Billion Center, 1 Wong Kwong Road,
 Kowloon Bay, Kowloon, Hongkong
 T: 00852-38192525 F: 00852-30116926
 E: info@hytronik.com

CHINA FACTORY
 3rd Floor, block C, complex building, 155#, Baigang road south,
 Baigang village, Xiao Jin Kou town, Hucheng district, Hudou 916023
 Tel:86-752-277877
 E: info@hytronik.com W:www.hytronik.com

**User Manual of Microwave Motion Sensor
 Detached version, Model No.: HC009S-KD**

Technical Specifications

- PRODUCT TYPE:** Microwave Motion Sensor
- OPERATING VOLTAGE:** 220-240VAC 50Hz/60Hz
- HF SYSTEM:** 5.8GHz CW radar
- TRANSMISSION POWER:** <0.2mW
- RATED LOAD:** 400VA(capacitive load)
- DETECTION ANGLE:** 30~150°
- POWER CONSUMPTION:** < 1W
- DETECTION RANGE:** Max. 12 meters in diameter, adjustable
10s ~ 30 min.
- TIME SETTING:**
- MOUNTING:** Indoors, ceiling & walling mounted
- LIGHT CONTROL:** 5 ~ 50LUX, disable
- WORKING TEMP.:** -20 ~ +60°C



Note: We recommend the mounting distance between sensor to sensor should be more than 2m to prevent sensors from false-triggering.

The sensor is an active motion detector. It emits a high-frequency electro-magnetic wave 5.8GHz and receives its echo. The sensor detects the change in echo from movement in its detection zone. A microprocessor then triggers the switch light ON command. Detection is possible through doors, panels of glasses thin walls.

NOTE: the high-frequency output of this sensor is <0.2mW; approximately just 0.1% of the transmission power of a mobile telephone or the output of a microwave oven.

IMPORTANT
 PLEASE READ THESE INSTRUCTIONS CAREFULLY PRIOR TO INSTALLATION AND RETAIN THIS LEAFLET IN A KNOWN AND SAFE PLACE FOR FUTURE REFERENCE.

SECTION 4 INSTALLATION & WIRING

2.1. ENSURE THAT THE ELECTRICITY SUPPLY IS SWITCHED OFF COMPLETELY BEFORE INSTALLING OR SERVICING THIS PRODUCT .



The sensor works with a main voltage of 220-240VAC 50Hz. A 100-120VAC version is available on request. The sensor has a 4-wire electrical interface:
 Nx2 (neutral / 220-240VAC)
 L (phase / 220-240VAC)
 L' (switched phase / output)

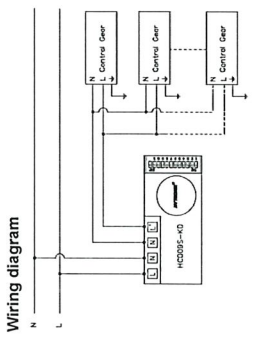

Wiring diagram

2.2 This sensor is suitable for indoor use, and is also designed for installation Max. 6m in height.

SECTION 2 SETTINGS

Detection range:
This determines the effective range of the motion detector, and is set by DIP switches at the sensor itself, refer to figure.
Note that reducing the sensitivity will also narrow the detection range.
The following settings are available:

| | | | | |
|---------------------------|---|---|---|------|
| | 1 | 2 | 3 | |
| I - Detection range 100% | ● | ● | ● | 100% |
| II - Detection range 75% | ● | ● | ○ | 75% |
| III - Detection range 50% | ● | ○ | ○ | 50% |
| IV - Detection range 25% | ○ | ○ | ○ | 25% |
| V - Detection range 10% | ○ | ○ | ○ | 10% |

- I - Detection range 100%
- II - Detection range 75%
- III - Detection range 50%
- IV - Detection range 25%
- V - Detection range 10%

Hold time:

This determines the time the fitting remains at 100% level on motion detection and is set with DIP switches at the sensor itself, refer to figure. The walk test setting is useful when installing the fitting to establish correct operation and range. The following settings are available:

| | | | | | |
|------------|---|---|---|---|-------|
| | 1 | 2 | 3 | 4 | |
| I - 30min | ● | ● | ● | ● | 30min |
| II - 20min | ● | ● | ○ | ○ | 20min |
| III - 6min | ○ | ○ | ○ | ○ | 6min |
| IV - 90s | ○ | ○ | ○ | ○ | 90s |
| V - 30s | ○ | ○ | ○ | ○ | 30s |
| VI - 10s | ○ | ○ | ○ | ○ | 10s |

- I - 30min
- II - 20min
- III - 6min
- IV - 90s
- V - 30s
- VI - 10s

Daylight sensor:

This setting holds off the ~100% light output should there sufficient daylight and is set using DIP switches at the sensor, refer to figure. The following settings are available:

| | | | | | |
|--------------|---|---|---|---|---------|
| | 1 | 2 | 3 | 4 | |
| I - disable | ● | ● | ● | ● | Disable |
| II - 50 lux | ● | ● | ○ | ○ | 50 Lux |
| III - 30 lux | ○ | ○ | ○ | ○ | 30 Lux |
| IV - 10 lux | ○ | ○ | ○ | ○ | 10 Lux |
| V - 5 lux | ○ | ○ | ○ | ○ | 5 Lux |

- I - disable
- II - 50 lux
- III - 30 lux
- IV - 10 lux
- V - 5 lux

*In disable mode the lamp(s) will always be on with motion detected and operate at 100% light output, even in bright daylight.

SECTION 3 SENSOR ANTENNA OPTIONS

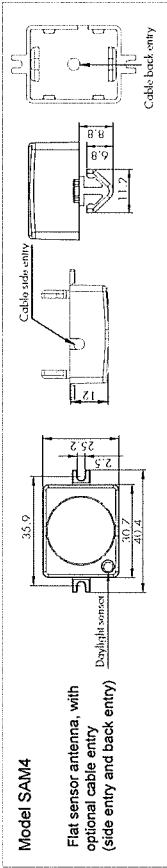
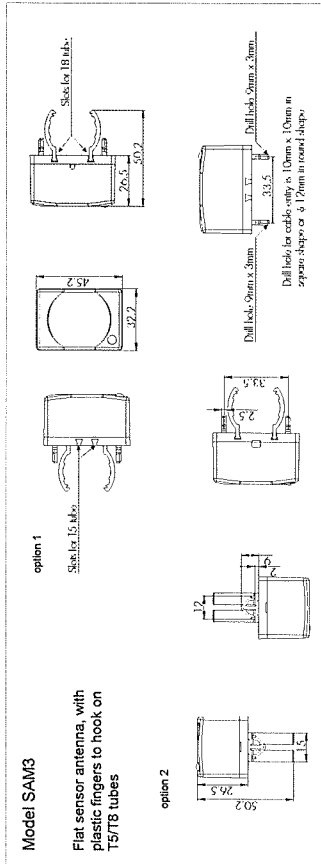
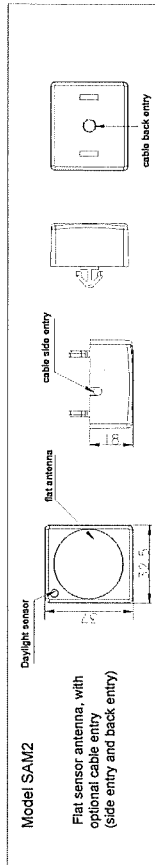

SECTION 4 FUNCTIONS

4.1 Zero-cross relay operation

Designed in the software, the sensor switches on/off the load right on the zero-cross point, to ensure the min. current passing through the relay contact point, and enable the max. load and life-time of the relay.

4.2 Loop-in and loop-out

Double L, N terminal makes it easy for wire loop-in and loop-out, saves the cost of terminal block and assembly time.

SECTION 5 TROUBLE SHOOTING

| MALFUNCTION CAUSE REMEDY | CAUSE | REMEDY |
|--|---|--|
| The load will not work | Incorrect light-control setting selected Load faulty | Adjust setting Replace load |
| The load is always on | Mains switch OFF Continuous movement in the detection zone | Switch ON Check zone setting |
| The load is on without any identifiable movement | The sensor is not mounted for reliably detecting movement Movement occurred, but not identified by the sensor (movement behind wall, movement of small object in immediate lamp vicinity etc.) | Securely mount enclosure Check zone setting |
| The load will not work despite movement | Rapid movements are being suppressed to minimize malfunctioning or the detection radius is too small | Check zone setting |

LED



Sicherheitshinweise

(D)



Safety Information

(GB)



Consignes de sécurité

(F)



Allgemeine Sicherheitshinweise

- Montage, Inbetriebnahme und Wartung nur durch Elektrofachkraft.
- Arbeiten Sie nie bei anliegender Spannung an der Leuchte. Lebensgefahr durch Stromschlag!
- Elektrischer Anschluss muss ordnungsgemäß, entsprechend allen geltenden Normen und sonstigen nationalen und internationalen Sicherheits- und Unfallverhütungsvorschriften erfolgen.
- Beschädigte Leuchten dürfen nicht betrieben werden.
- Sicherheitshinweise und Montageanleitung beachten und aufbewahren
- Keine Haftung für Schäden durch unsachgemäßen Einsatz.
- Bei Instandsetzung nur Originalteile verwenden.
- Tragfähigkeit der Decke und Befestigungselemente sicherstellen.
- Leuchte ausschließlich für Innenraumeinsatz und Umgebungstemperaturen bis 25°C geeignet, sofern mittels Etikettierung der Leuchte nicht anders beschrieben.



Betrieb der Leuchte

- Ungewöhnliche Dunkelstellen können auf Teilausfall von LED hinweisen. Regelmäßig prüfen und betroffene Leuchten austauschen. Die Lichtquelle (LED) dieser Leuchte darf nicht durch den Anwender ausgetauscht oder ersetzt werden.
- Eine Überschreitung der zulässigen Umgebungstemperatur reduziert die Lebensdauer der Leuchte, im Extremfall droht Frühausfall.
- Die Betauung der Leuchte ist zu vermeiden.
- Jegliche mechanische Belastung der LED Platinen ist unzulässig.
- LED können durch elektrostatische Entladung (ESD) geschädigt werden, bis hin zum Totalausfall. Direkte Berührung ist stets zu vermeiden.
- In Abhängigkeit von deren Konzentration können Chemikalien die LED-Module angreifen und zu Lichtstromreduktion, Drift der Lichtfarbe bzw. Totalausfall führen. Direkter Kontakt mit Säuren, Laugen, Lösemitteln, flüchtigen organischen Verbindungen bzw. Ölen ist stets zu vermeiden. Um Schäden durch Ausgasungen zu vermeiden, ist eine ausreichende Be- und Entlüftung zu gewährleisten.
- Zur Vermeidung von EMV-Problemen Durchgangsverdrahtung nicht unmittelbar entlang der Leuchtenverdrahtung führen.
- Steuereingänge von dimmbaren Leuchten mit handelsüblichen für Netzspannung geeigneten Leitungen anschließen.



Änderungen unserer Produkte

Veränderung, Umarbeitung, Umkenzeichnung von Produkten können deren technische Eigenschaften negativ beeinflussen, diese zerstören und möglicherweise Folgeschäden an anderen Objekten verursachen. Für durch derartige Änderungen verursachte Schäden kann der Hersteller nicht verantwortlich gemacht werden.

- ▽ + IP5x - nicht leitfähiger Staub
- ▽ + IP6x - leitfähiger und nicht leitfähiger Staub



General Safety Information

- Installation, commissioning and maintenance only by qualified electrician.
- Never perform any work on the luminaire with voltage applied. Danger to life due to electric shock!
- Electric connection must be appropriate according to all applicable standards and other national and international safety and accident prevention regulations.
- Damaged luminaires must not be operated.
- Observe and retain safety instructions and mounting instructions
- No liability is accepted for damages resulting from improper use.
- Use genuine parts only for repair.
- Ensure stability of the ceiling and fastening elements.
- The luminaire is exclusively intended for interior rooms and ambient temperatures not exceeding 25°C, unless otherwise described by labeling the luminaire.



Operation of the luminaire

- Abnormal dark spots may be an indication of partial failure of LEDs. Inspect regularly and replace the luminaires affected. The light source (LED) of this luminaire must not be exchanged or replaced by the user.
- Exceeding the permissible ambient temperature will reduce the luminaire's lifecycle, resulting in premature failure in extreme cases.
- Avoid condensation of the luminaire.
- Any mechanical load to the LED circuit boards is not permitted.
- LEDs can be damaged by electrostatic discharge (ESD). This may result in total failure. Always avoid direct contact.
- Depending on their concentration, chemicals can corrode the LED modules and lead to reduction of luminous flux, drift of luminous colour and/or total failure. Always avoid direct contact with acids, bases, solvents, volatile organic compounds and/or oils. Ensure sufficient ventilation to prevent damage by gas release.
- Avoid ESD problems by not routing feed-through wiring directly along the wiring of the luminaire.
- Connect control inputs of dimmable luminaires with standard cables suitable for power supply voltage.



Changes to our products

Modification, reworking, re-marking of products can have a negative impact on their technical properties, destroy them and possibly cause consequential damage to other objects. The manufacturer cannot be held responsible for damage caused by such changes.

- ▽ + IP5x - dust nonconductive
- ▽ + IP6x - dust conductive and dust nonconductive



Consignes générales de sécurité

- Montage, mise en service et maintenance uniquement par un électricien spécialisé.
- Ne travaillez jamais sur un luminaire sous tension. Danger de mort par choc électrique !
- Le branchement électrique doit être réalisé de manière correcte et conforme à toutes les normes en vigueur et autres prescriptions nationales et internationales relatives à la sécurité et à la prévention des accidents.
- Ne pas faire fonctionner de luminaires défectueux.
- Respecter et conserver les consignes de sécurité et les instructions de montage
- Nous déclinons toute responsabilité en cas de dommages dus à une utilisation incorrecte.
- Utiliser uniquement des pièces d'origine pour la réparation.
- Veiller à ce que la capacité portante du plafond et des éléments de fixation soit suffisante.
- Sauf indication contraire indiquée sur l'étiquette du luminaire, luminaire conçu uniquement pour une utilisation en intérieur et une température ambiante maximale de 25 °C.



Fonctionnement du luminaire

- Des zones d'ombre inhabituelles peuvent indiquer un défaut partiel des LED. Contrôler régulièrement et remplacer les luminaires concernés. Utilisateur n'est pas autorisé à échanger ou à remplacer la source de lumière (LED) de ce luminaire.
- Le dépassement des températures ambiantes admissibles réduit la longévité du luminaire; dans les cas extrêmes, cela peut entraîner des pannes prématurées.
- Éviter toute condensation sur le luminaire.
- Ne jamais soumettre les platines à LED à des charges mécaniques.
- Les décharges électrostatiques (DES) peuvent endommager les LED et entraîner leur destruction totale. Toujours éviter le contact direct.
- En fonction de leur concentration, les produits chimiques peuvent attaquer les modules à LED et entraîner une baisse du flux lumineux, une dérive de la température de couleur voire une panne totale. Toujours éviter le contact direct avec les acides, les lessives alcalines, les solvants, les composés et huiles organiques volatils. Assurer une ventilation et une aération suffisantes pour éviter les dégâts dus aux dégagements de gaz.
- Pour éviter les problèmes de CEM, ne pas poser le câblage de liaison directement à côté du câblage du luminaire.
- Brancher les entrées de commande des luminaires à gradation à l'aide de câbles standard adaptés à la tension secteur.



Modification de nos produits

La modification, la transformation et la modification de marquage des produits peuvent avoir une influence négative sur leurs propriétés techniques, détériorer les produits et causer des dommages indirects sur d'autres objets. Le fabricant ne saurait être tenu responsable des dommages causés par ces modifications.

- ▽ + IP5x - non conductrice de la poussière
- ▽ + IP6x - poussière conductrice et de la poussière non conductrice

Information für Wartung, Reinigung und Entsorgung von LED-Leuchten Information for service, cleaning and disposal of luminaire

Instruktion für Wartung von Leuchten: Instruction for luminaire service:

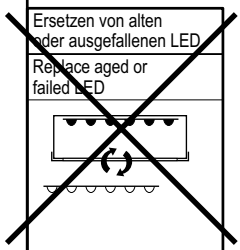

**Instruktion für Ende der Lebensdauer:
Instruction for end of life :**

Ausschalten, Stromzufuhr zur Leuchte unterbrechen
Switch off, switch off supply to luminaire



Batterie entfernen zur Entsorgung
Remove battery for disposal

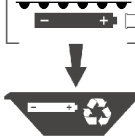

Leuchte entfernen zur Entsorgung
Remove luminaire for disposal



Das Material an WEEE Entsorgungsstelle liefern
Dispatch materials to WEEE recycling plant



Instruktion für Reinigung von Leuchten: Instruction for luminaire cleaning

Leuchte reinigen
Clean luminaire

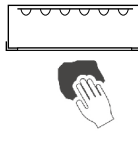

Ausschalten, Stromzufuhr zur Leuchte unterbrechen
Switch off, switch off supply to luminaire

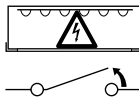

Leuchte außen reinigen
Clean outside luminaire

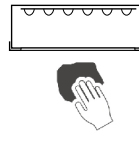

Optik entfernen
Remove optic



Nur bei SELV! Only SELV!
Leuchte innen reinigen
Clean inside luminaire



Optik wieder anbringen
Refit optic



Funktionstest durchführen
Make functional test



**Advertencias de seguridad**

E

**Avvertenze sulla sicurezza**

I

**Zasady bezpieczeństwa**

PL

**Advertencias de seguridad generales**

- El montaje, la puesta en funcionamiento y el mantenimiento deberán ser realizados exclusivamente por electricistas profesionales.
- No realice nunca trabajos en la luminaria cuando esta esté sometida a tensión. ¡Peligro de muerte por descarga eléctrica!
- La conexión eléctrica se debe realizar de modo reglamentario, de conformidad con todas las normas vigentes y con las demás prescripciones nacionales e internacionales de seguridad y prevención de accidentes.
- Tenga en cuenta las advertencias de seguridad y las instrucciones de montaje y conserve los documentos correspondientes como referencia.
- No se asume ninguna responsabilidad por daños debidos a un uso antirreglamentario.
- Al hacer reparaciones, utilice exclusivamente piezas originales.
- Asegúrese de que el techo y los elementos de fijación tengan la capacidad de carga suficiente.
- A menos que se describa lo contrario etiquetando la luminaria, la luminaria es apta exclusivamente para su uso en interiores y a una temperatura ambiente de hasta 25 °C.

**Funcionamiento de la luminaria**

- La aparición de puntos oscuros inusuales puede ser indicio de la avería de algunos ledes. Realice revisiones periódicas y sustituya las luminarias defectuosas.
- El rebase de la temperatura ambiente permitida conlleva una reducción de la vida útil de la luminaria y, en casos extremos, el riesgo de una avería prematura.
- Se debe evitar la condensación en la luminaria.
- Está prohibida toda carga mecánica sobre las pletinas de los ledes.
- Una descarga electrostática podría provocar daños en los ledes e incluso una avería total. Se deberá evitar siempre el contacto directo con estos.
- Según su grado de concentración, los productos químicos pueden atacar los módulos de ledes y provocar una reducción del flujo luminoso, alteraciones en el tono de la luz o una avería total. Se debe evitar bajo cualquier circunstancia el contacto directo con ácidos, lejías, disolventes, compuestos orgánicos volátiles o aceites. Para evitar daños debidos a las emisiones de gas, es necesario garantizar una ventilación suficiente de entrada y salida.
- Para evitar problemas de compatibilidad electromagnética, no tienda los cables de paso junto a los cables de la luminaria.
- Conecte las entradas de mando de luminarias atenuables mediante cables convencionales adecuados para tensión de red.

Modificaciones de nuestros productos

La modificación, la reelaboración y el remarcado de los productos pueden influir negativamente en sus propiedades técnicas, destruirlos y, posiblemente, causar los consiguientes daños a otros objetos. El fabricante no se hace responsable de los daños causados por dichas modificaciones.

▽+ IP5x - polvo no conductor

▽+ IP6x - polvo conductor y no conductor

**Avvertenze generali sulla sicurezza**

- Il montaggio, l'impiego e la manutenzione devono essere eseguiti solo da un elettricista specializzato.
- Non lavorare mai sulla lampada con tensione elettrica inserita. Pericolo di morte a causa di scossa elettrica!
- L'allacciamento elettrico deve essere eseguito a regola d'arte, in conformità a tutte le norme vigenti, alle disposizioni nazionali e internazionali di sicurezza e alle normative antinfortunistiche.
- Le lampade danneggiate non devono essere utilizzate ulteriormente.
- Osservare e conservare le avvertenze di sicurezza e le istruzioni di montaggio.
- Non lavorare mai sulla lampada con tensione elettrica inserita.
- Per le riparazioni utilizzare solo parti di ricambio originali.
- Verificare la portata del soffitto e degli elementi di fissaggio.
- La lampada è prevista solo per uso interno e temperature ambiente fino a 25 °C, se non diversamente descritto dall'etichettatura dell'apparecchio.

**Funzionamento della lampada**

- Punti scuri insoliti possono indicare un guasto parziale dei LED. Controllare regolarmente e sostituire le lampade in questione.
- Il superamento della temperatura ambiente consentita riduce la durata utile della lampada, in casi estremi si rischia un guasto precoce.
- Evitare la condensazione della lampada.
- È vietata qualsiasi sollecitazione meccanica delle schede LED.
- I LED possono essere danneggiati dalle scariche elettrostatiche (ESD), con possibilità di guasto totale. Si deve sempre evitare il contatto diretto.
- In rapporto alla loro concentrazione, le sostanze chimiche possono aggredire i moduli LED provocando la riduzione del flusso luminoso, la deriva del colore della luce o un guasto totale. Si deve sempre evitare il contatto diretto con acidi, basi, solventi, composti organici volatili o oli. Per evitare danni da emissioni di gas, si deve garantire una sufficiente ventilazione e disaerazione.
- Per evitare problemi di CEM, il cablaggio di transito non deve essere posato direttamente insieme al cablaggio della lampada.
- Collegare gli ingressi di comando delle lampade dimmerabili (varialuce) usando dei cavi adeguati per la tensione di rete.

Modificaciones de nuestros productos

Modifiche, conversioni, cambi dell'etichettatura apportati ai prodotti possono influenzare negativamente le loro proprietà tecniche, distruggerli ed eventualmente causare danni ad altri oggetti. Il produttore non può essere ritenuto responsabile di eventuali danni causati da tali modifiche.

▽+ IP5x - polvere non conduttiva

▽+ IP6x - polvere conduttiva e non conduttiva

**Ogólne zasady bezpieczeństwa**

- Prace związane z montażem, uruchomieniem i konserwacją może wykonywać tylko elektryk.
- Nigdy nie wykonywać prac przy oprawie, gdy znajduje się ona pod napięciem. Niebezpieczeństwo dla życia z powodu porażenia prądem!
- Przyłącze elektryczne musi być wykonane profesjonalnie, zgodnie ze wszystkimi obowiązującymi normami oraz innymi krajowymi i międzynarodowymi przepisami bezpieczeństwa i zapobiegania wypadkom.
- Przestrzegać zasad bezpieczeństwa i wytycznych instrukcji montażu oraz zachować je do późniejszego użytku.
- Producent nie ponosi odpowiedzialności za nieprawidłowe stosowanie.
- W przypadku naprawy używać tylko oryginalnych części.
- Zapewnić nośność sufitu i elementów mocujących.
- Oprawa przeznaczona jest wyłącznie do stosowania w pomieszczeniach w temperaturach otoczenia do 25 °C, o ile nie opisano inaczej, oznaczając oprawę.

Eksploatacja oprawy

- Nietypowe zaciemnione miejsca mogą wskazywać na częściową awarię oprawy LED. Należy regularnie dokonywać kontroli i wymieniać uszkodzone oprawy.
- Przekroczenie dopuszczalnej temperatury otoczenia skracza trwałość oprawy, w skrajnym przypadku grozi przedwczesną awarią.
- Unikać obrobienia oprawy.
- Niedopuszczalne jest jakiegokolwiek obciążenie mechaniczne płytek LED.
- Diody LED mogą ulec uszkodzeniu wskutek wyładowania elektrostatycznego (ESD), a nawet ulec całkowitej awarii. Zawsze należy unikać bezpośredniego kontaktu.
- W zależności od stężenia chemikalia mogą uszkodzić moduły LED i prowadzić do obniżenia strumienia światła, zmiany barwy światła lub całkowitej awarii. Zawsze należy unikać bezpośredniego kontaktu z kwasami, ługami, rozpuszczalnikami, lotnymi związkami organicznymi lub olejami. Celem uniknięcia szkód z powodu emisji gazów należy zapewnić odpowiednią wentylację i odpowietrzanie.
- Aby uniknąć problemów EMC, nie prowadzić okablowania przelotowego bezpośrednio wzdłuż okablowania oprawy.
- Wejścia sterujące opraw z funkcją ściemniania podłączać za pomocą dostępnych powszechnie w sprzedaży przewodów odpowiednich od napięcia sieciowego.

Zmiany naszych produktów

Zmiany, przeróbki, modyfikacja oznaczeń produktów mogą mieć negatywny wpływ na ich parametry techniczne, spowodować ich awarię, a także być możliwą przyczyną powstania szkód następczych w innych obiektach. Producent nie odpowiada za szkody spowodowane tego typu modyfikacjami.

▽+ IP5x - pył nieprzewodzący

▽+ IP6x - pył przewodzący i nieprzewodzący

BG



Инструкциите за безопасност на вашия национален език можете да намерите Интернет.

DK



Sikkerhedsinstruktionerne på dit lands sprog findes på Internettet.

EST



Riikliku keele ohutusjuhiseid leiab Internetist.

HR



Sigurnosne upute na vašem nacionalnom jeziku mogu se naći na Internetu.

LV



Drošības norādījumus savā valsts valodā var atrast internetā.

LT



Saugos nurodymus savo valstybine kalba galima rasti internete.

N



Sikkerhetsinstruksjonene på ditt nasjonalspråk finnes på Internett.

P



As instruções de segurança em sua língua nacional podem ser encontradas na Internet.

RO



Instrucțiunile de siguranță din limba dvs. națională pot fi găsite pe Internet.

S



Säkerhetsanvisningarna på ditt nationella språk finns på Internet.

SK



Bezpečnostné pokyny vo vašom národnom jazyku nájdete na internetovej.

SLO



Varnostna navodila v vašem nacionalnem jeziku so na voljo na spletni strani.

CZ



Bezpečnostní pokyny ve vašem národním jazyce naleznete na internetu.

TR



Ulusal dilinizdeki güvenlik talimatları internette.

H



A nemzeti nyelvű biztonsági utasítások megtalálhatók az interneten.

CY



Οι οδηγίες ασφάλειας στην εθνική σας γλώσσα διατίθενται στο διαδίκτυο.

GR